

**NEC**

ND-91712(E)

ISSUE 5

# **NEAX 2400 IPX**

*Internet Protocol eXchange*

**D<sup>term</sup> Series i / D<sup>term</sup> IP USER'S GUIDE**

MARCH, 2005

NEC Corporation

## **LIABILITY DISCLAIMER**

NEC Corporation reserves the right to change the specifications, functions, or features, at any time, without notice.

NEC Corporation has prepared this document for use by its employees and customers. The information contained herein is the property of NEC Corporation and shall not be reproduced without prior written approval from NEC Corporation.

Copyright 2005

**NEC Corporation**

Printed in Japan





## Table of Contents

Face Layout.....	1	Forced Account Code.....	44
Rear View .....	15	Authorization Code .....	45
Base View.....	18	Voice Call.....	45
Keys and Lamps .....	19	To Answer a Voice Call Hands Free .....	46
Soft Keys .....	21	Automatic Intercom .....	47
Terminal Setup with the Up/Down Key .....	28	Manual Intercom.....	48
Terminal Setup with the Feature Key .....	30	Dial Intercom .....	49
Login/Logout		To Place a Call on Hold .....	50
(IP Enabled D <sup>term</sup> /D <sup>term</sup> IP Only) .....	34	To Place a Call on Exclusive Hold.....	50
To Originate an Outside Call .....	36	To Transfer a Call.....	51
To Originate an Internal Call.....	36	Conference .....	52
Multiline Appearance .....	36	To Establish a Broker Call.....	52
To Originate a Call Using Speed Calling		To Answer a Camped-on Call .....	53
(One-touch Speed Calling keys).....	37	Call Waiting – Originating .....	53
LCD Indication of		Call Park.....	55
Dterm16LD, Dterm16LDIP and 16LD ADM .	38	Call Pick-up (Group) .....	56
To Register Name On		Call Pick-up (Direct).....	56
One-Touch Speed Calling Key.....	39	Outgoing Trunk Queuing.....	57
To Originate a Call Using Speed Calling		Off-hook Trunk Queuing.....	57
(-Station/Group) .....	40	Executive Override.....	58
To Originate a Call Using		Last Number Redial .....	58
Speed Calling – System.....	40	Call Forwarding – All Calls.....	59
To Originate a Call Using		Call Forwarding – Busy Line.....	60
Telephone Directory (16LD ADM) .....	41	Call Forwarding – Don't Answer.....	62
To Originate a Call Using Calling History .....	43	Logged Out IP Station – Call Destination .....	63
Account Code .....	44	Call Back.....	65

## Table of Contents

To Save and Repeat a Number .....	66
To Leave a Message .....	67
To Answer a Message .....	67
Voice Mail System .....	68
Meet-me Paging .....	69
Paging Transfer .....	70
Boss/Secretary Transfer .....	71
Boss/Secretary – MW Lamp Control.....	72
Boss/Secretary Override.....	73
Do Not Disturb .....	74
Call Redirect.....	75
Privacy.....	77
Privacy Release .....	78
LCD Indication .....	79
Index .....	83

## Face Layout

**D<sup>term</sup>4D IP**

(4-LINE WITH DISPLAY)

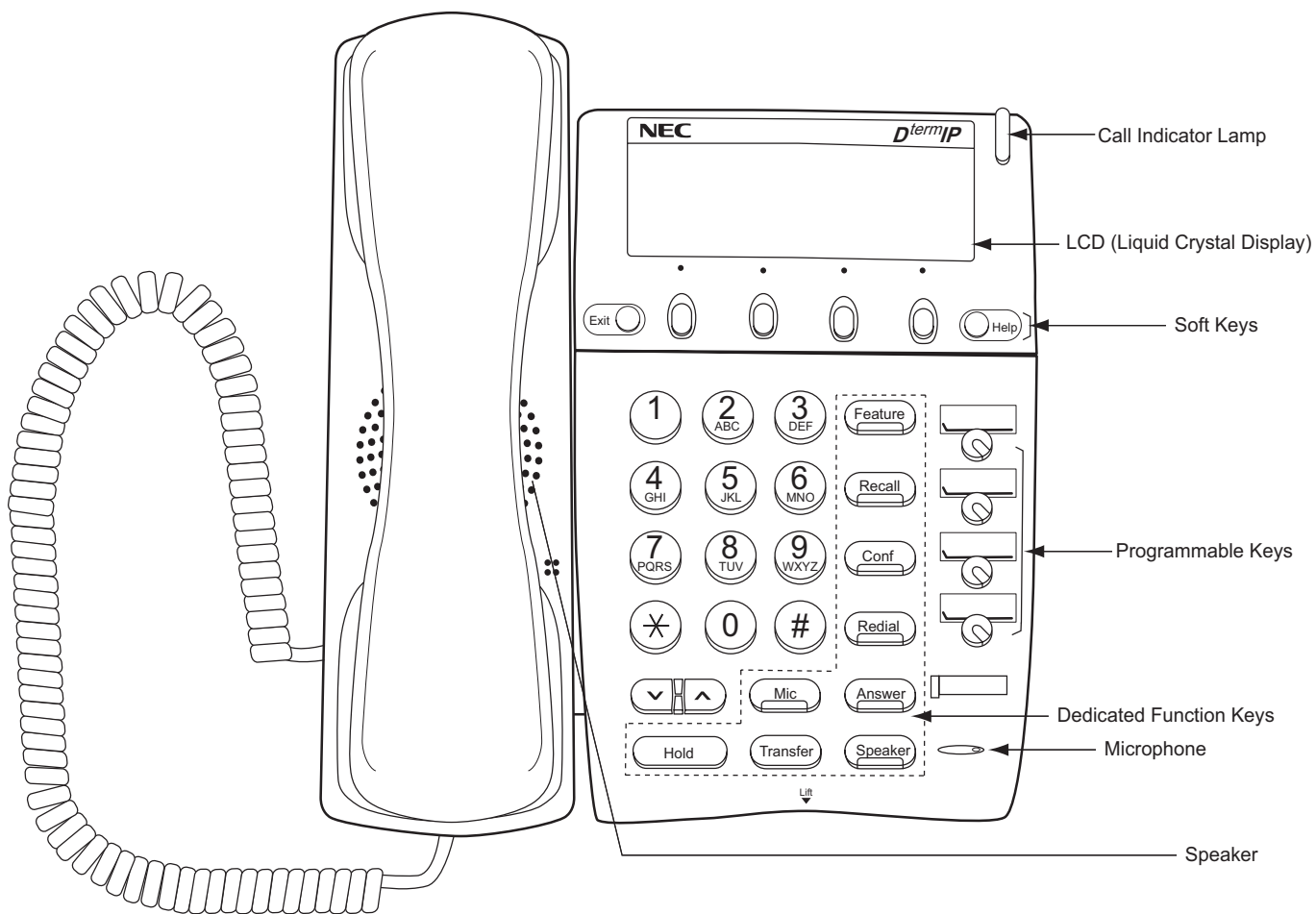

**Dterm8**  
(8-LINE NON DISPLAY)

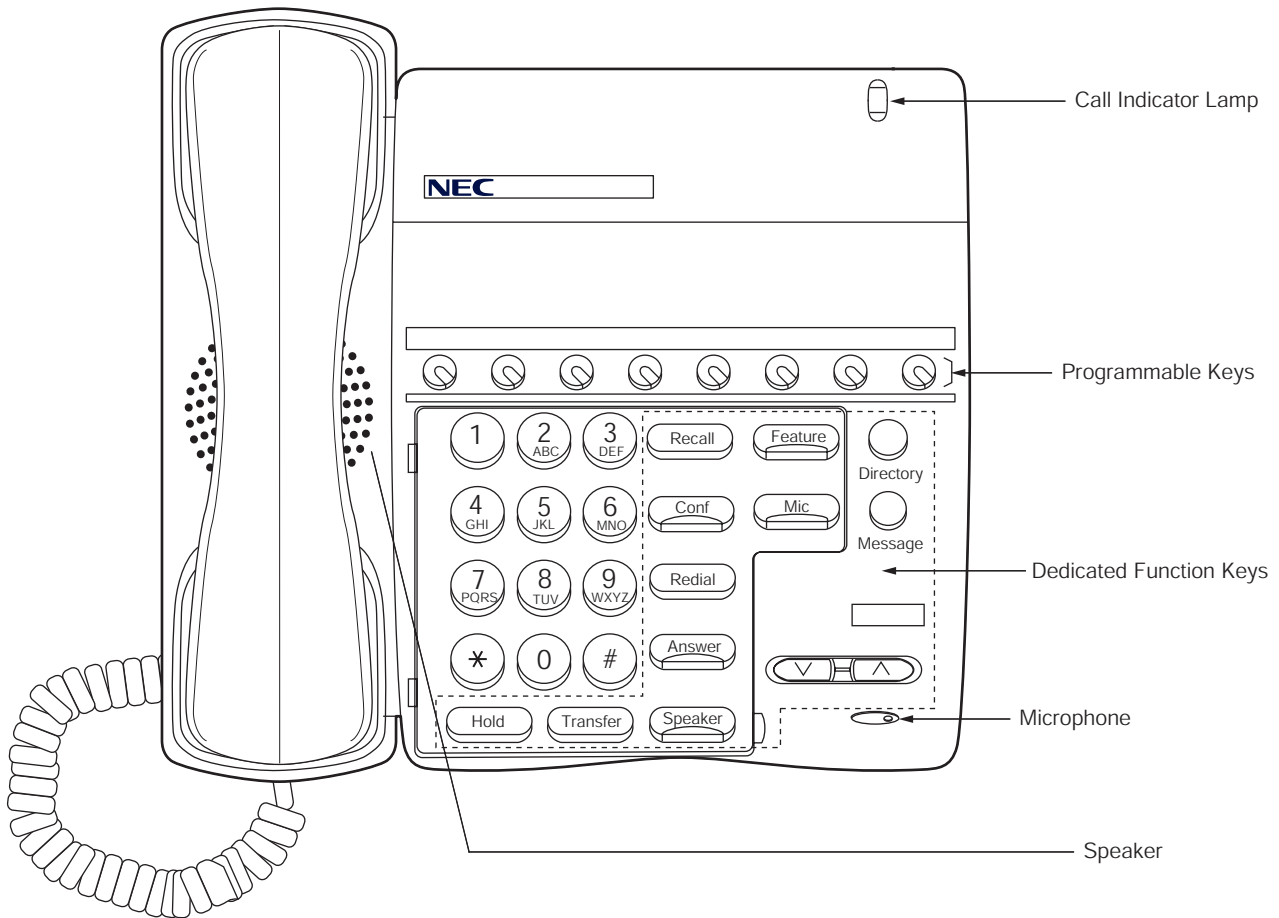



**D<sup>term</sup>8D and D<sup>term</sup>8D IP**  
(8-LINE WITH DISPLAY)

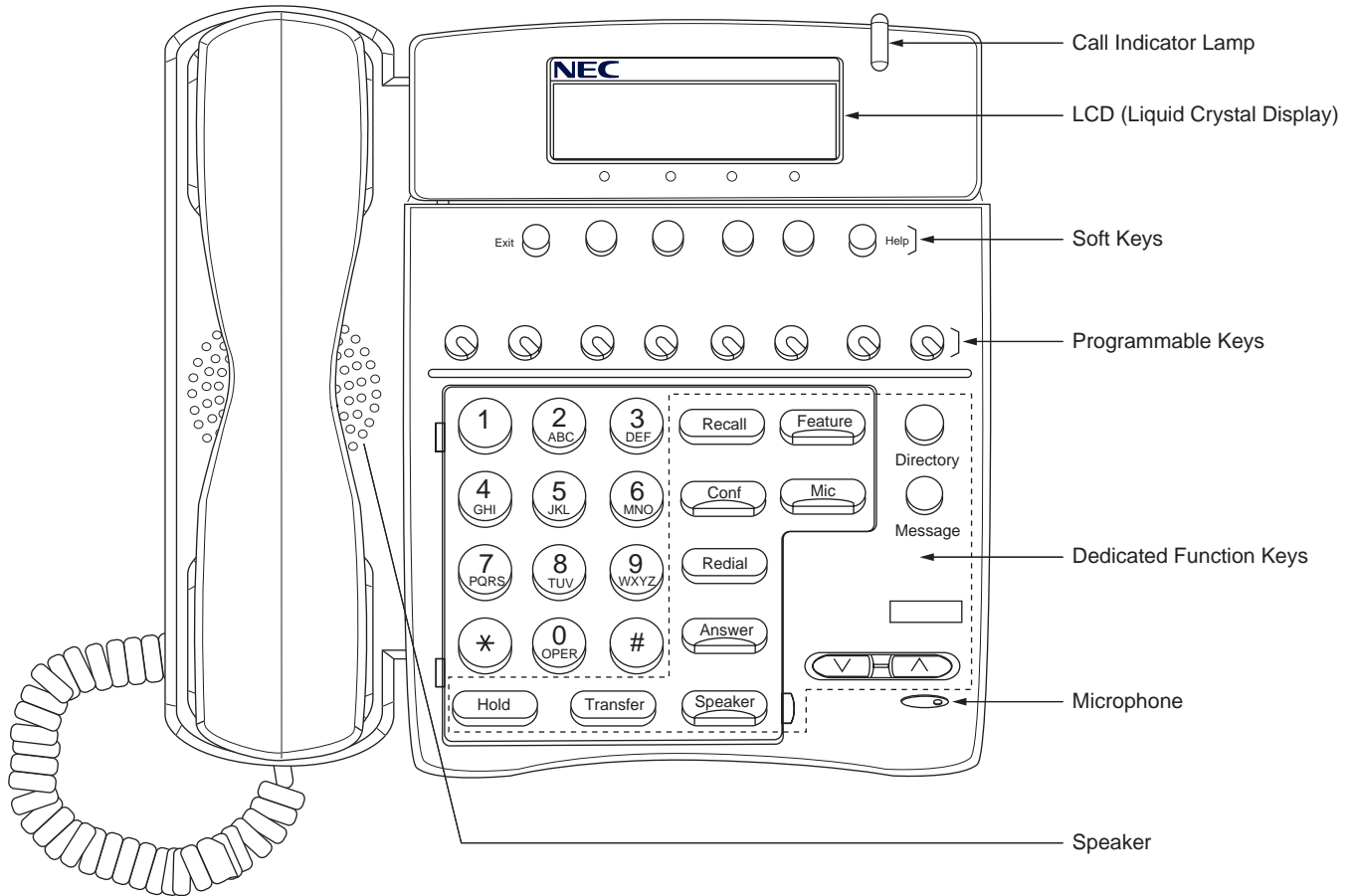

**D<sup>term</sup>16D and D<sup>term</sup>16D IP**  
 (16-LINE WITH DISPLAY)

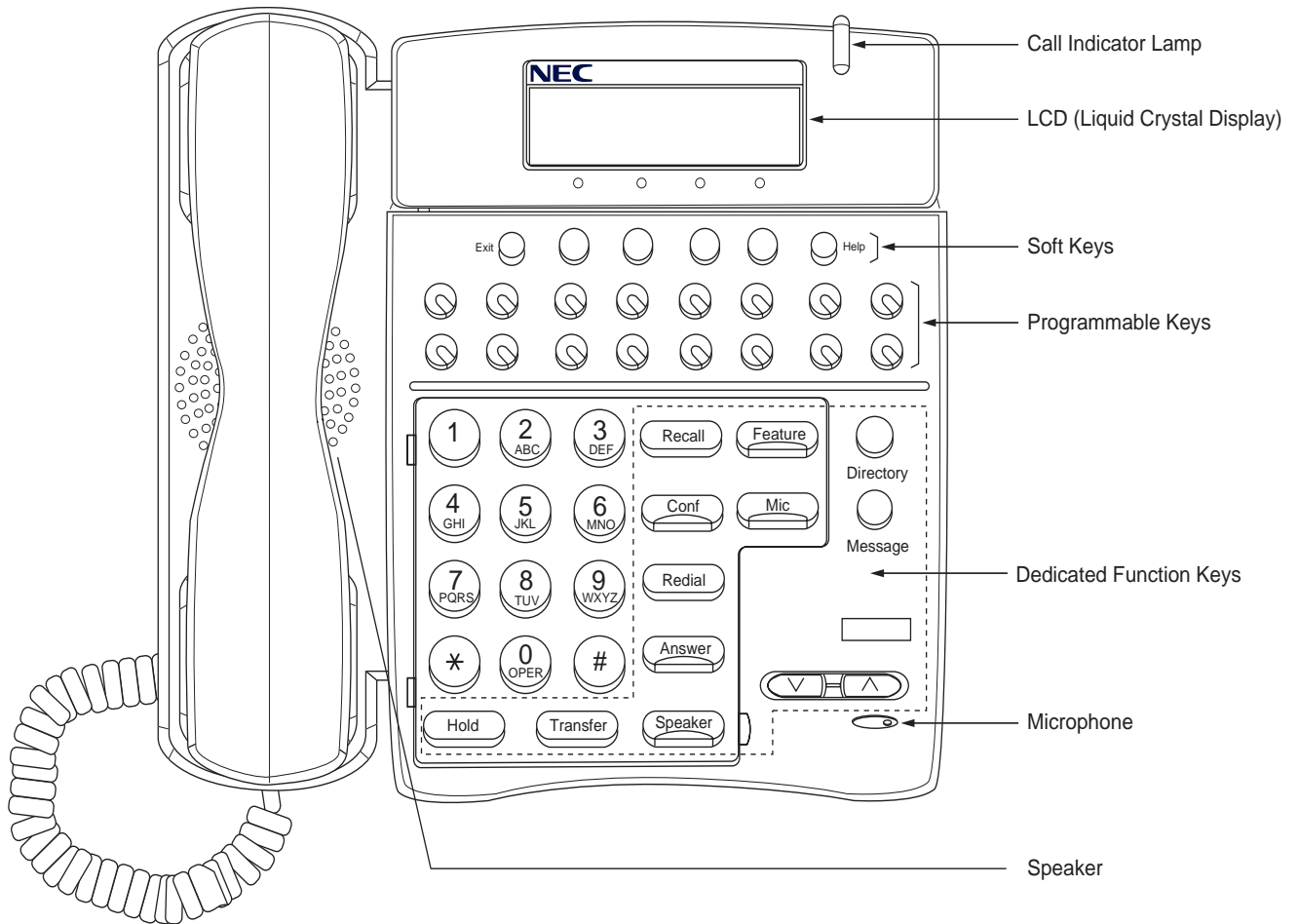

## D<sup>term</sup>32D and D<sup>term</sup>32D IP

(32-LINE WITH DISPLAY)

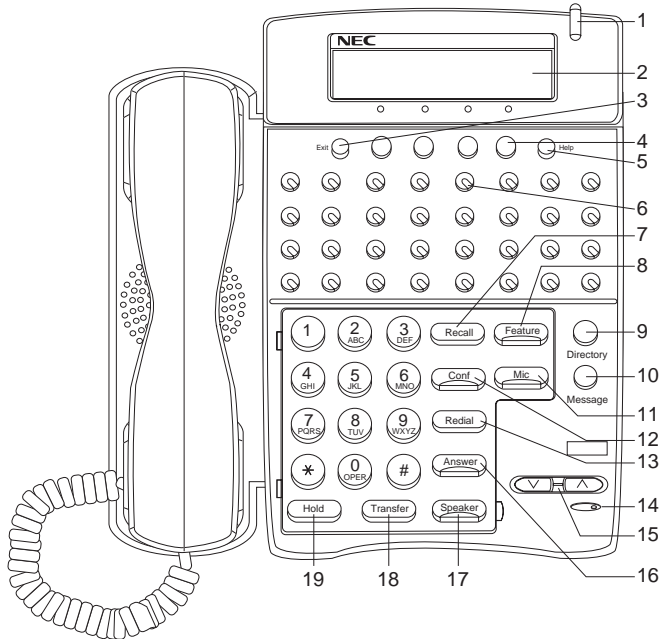

### 1 Call Indicator Lamp

Lamp at top corner of D<sup>term</sup> Display flashes when a call terminates to the terminal.

Lamp lights steadily when a message has been left.

### 2 LCD (Note 1)

LCD (Liquid Crystal Display) provides D<sup>term</sup> activity information plus data, time and Soft Key Operation. The LCD has 24-character, 3-line capability.

### 3 Exit

The user can exit from the Help key mode by pressing this key.

### 4 Soft Keys

Any feature shown at the bottom of the LCD is available. The appropriate feature key is displayed on the screen according to the call handling process.

### 5 Help

Explanations of the Soft Keys can be called up on the LCD by pressing this key.

## 6 Programmable Keys

These keys can be programmed as Flexible Line key/Programmable Feature Key by Telephony Server Administrator.

When Telephony Server Administrator sets “One-Touch Speed Dial key” on the programmable keys, users can assign any numbers (ex. Telephone number, etc.) to the key (up to 24 digits). **(Note 2)**

\* For the assignment of the keys, confirm to the Telephony Server Administrator.

\*\* When two telephone numbers are assigned on A side and B side of “One-Touch Speed Dial key”, user can switch the side by **PAGE** key (Soft key).

## 7 Recall

Press key to finish the call and hear the dial tone.

## 8 Feature

Used to activate any features as terminal setup functions, etc. and to program One-Touch Speed Dial Keys.

## 9 Directory (Note 3)

Press key to activate speed calling - system feature.

\* Not equipped on *D<sup>term</sup> 4D IP*.

## 10 Message (Note 3)

Press key to access the voice mail system.

\* Not equipped on *D<sup>term</sup> 4D IP*.

## 11 Mic

Press key to respond hands free. LED on this key lights during speakerphone operation.

## 12 Conf

Press key to establish a three-way conversation. LED on key lights when key is active.

## 13 Redial

(Last Number Call, Speed Calling-Station/Group)  
Press key to activate redial feature. Press redial and scroll back through numbers that have been dialed.

When the desired number is displayed, press the ✕ or # **(Note 4)** key to activate dialing.

## 14 Microphone

Built-in microphone is used for hands free operation with speakerphone.

## 15 Up/Down

(∇ DOWN ^ UP)

Used to adjust LCD contrast, speaker/receiver volume, and ringer volume.

- LCD Contrast:  
Press (∇) or (^) key while idle.
- Speaker/Receiver Volume:  
Press (∇) or (^) key during conversation.
- Ringer Volume:  
Press (∇) or (^) key during ringing.

## 16 Answer

When LED on this key is lit, press key to answer a waiting call.

## 17 Speaker

Controls the built-in speaker which can be used for Hands Free dialing/monitoring.

LED on key lights when key is active.

\* All standard IP versions include support for full duplex handsfree mode. All TDM and IP enabled versions are half duplex handsfree mode.

## 18 Transfer

Allows the station user to transfer established calls to another station, without attendant assistance.

## 19 Hold

Press key to place an internal or external call on hold.

## 20 D<sup>term</sup> IP Adapter

D<sup>term</sup> IP adapter can be attached to D<sup>term</sup> Series i 8D/16D/32D terminals. It supports the same telephony service as the original D<sup>term</sup> terminal.



**Note 1:** *Not applicable for D<sup>term</sup> 8.*

**Note 2:** *Not applicable for D<sup>term</sup> 8/8D/16D.*

**Note 3:** *Not available for D<sup>term</sup> 65/D<sup>term</sup> Series III mode, D<sup>term</sup> 75/D<sup>term</sup> Series E mode.*

*(These keys must be enabled in system programming and must be used with the correct Firmware.)*

*D<sup>term</sup> Series III/D<sup>term</sup> Series E: North America*

*D<sup>term</sup> 65/D<sup>term</sup> 75: Australia, Asia, Latin America, Middle East, Russia*

**Note 4:** *A-law Countries [Australia, Russia, Latin America, UK, Middle near East, other Asian nations]: #*

*μ-law Countries [North America, Japan, Hong Kong, Taiwan]: ✕*

# D<sup>term</sup>16LD and D<sup>term</sup>16LD IP

(DESI-less 16LD Phone)

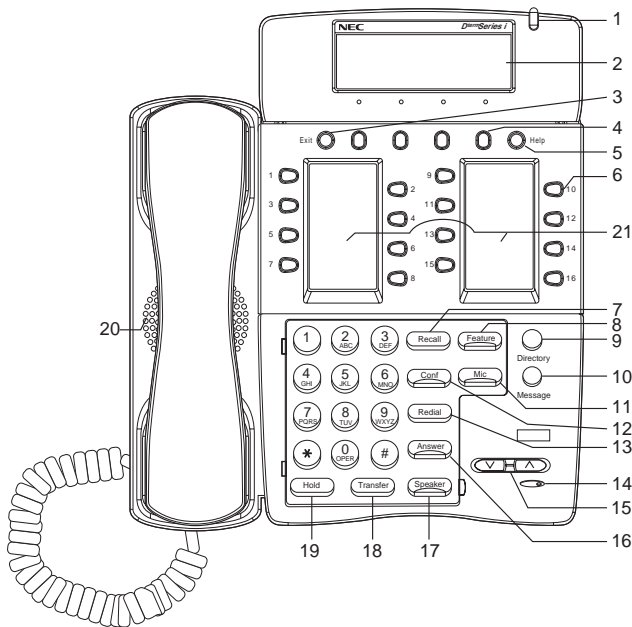

## 1 Call Indicator Lamp

Lamp at top corner of D<sup>term</sup> Display flashes when a call terminates to the terminal.  
Lamp lights steadily when a message has been left.

## 2 LCD (Note 1)

LCD (Liquid Crystal Display) provides D<sup>term</sup> activity information plus data, time and Soft Key Operation. The LCD has 24-character, 3-line capability.

## 3 Exit

The user can exit from the Help key mode by pressing this key.

## 4 Soft Keys

Any feature shown at the bottom of the LCD is available. The appropriate feature key is displayed on the screen according to the call handling process.

## 5 Help

Explanations of the Soft Keys can be called up on the LCD by pressing this key.

## 6 Programmable Keys

These keys can be programmed as Flexible Line key/Programmable Feature Key by Telephony Server Administrator.

When Telephony Server Administrator sets “One-Touch Speed Dial key” on the programmable keys, users can assign any numbers (ex. Telephone number, etc.) to the key (up to 24 digits). **(Note 2)**

\* For the assignment of the keys, confirm to the Telephony Server Administrator.

\*\* When two telephone numbers are assigned on A side and B side of “One-Touch Speed Dial key”, user can switch the side by **PAGE** key (Soft key).

## 7 Recall

Press key to finish the call and hear the dial tone.

## 8 Feature

Used to activate any features as terminal setup functions, etc. and to program One-Touch Speed Dial Keys.

## 9 Directory (Note 3)

Press key to activate speed calling - system feature.

\* Not equipped on *D<sup>term</sup> 4D IP*.

## 10 Message (Note 3)

Press key to access the voice mail system.

\* Not equipped on *D<sup>term</sup> 4D IP*.

## 11 Mic

Press key to respond hands free. LED on this key lights during speakerphone operation.

## 12 Conf

Press key to establish a three-way conversation. LED on key lights when key is active.

## 13 Redial

(Last Number Call, Speed Calling-Station/Group)

Press key to activate redial feature. Press redial and scroll back through numbers that have been dialed.

When the desired number is displayed, press the ✕ or # **(Note 4)** key to activate dialing.

## 14 Microphone

Built-in microphone is used for hands free operation with speakerphone.

## 15 Up/Down

(∇ DOWN ^ UP)

Used to adjust LCD contrast, speaker/receiver volume, and ringer volume.

- LCD Contrast:  
Press (∇) or (^) key while idle.
- Speaker/Receiver Volume:  
Press (∇) or (^) key during conversation.
- Ringer Volume:  
Press (∇) or (^) key during ringing.

## 16 Answer

When LED on this key is lit, press key to answer a waiting call.

## 17 Speaker

Controls the built-in speaker which can be used for Hands Free dialing/monitoring.

LED on key lights when key is active.

## 18 Transfer

Allows the station user to transfer established calls to another station, without attendant assistance.

## 19 Hold

Press key to place an internal or external call on hold.

## 20 Speakerphone

Controls the built in speaker which can be used for handsfree dialing/monitoring LED on speaker key lights when active.

\* All standard IP version include support for full duplex handsfree. All TDM and IP enabled versions are half duplex handsfree.

## 21 16LD Display

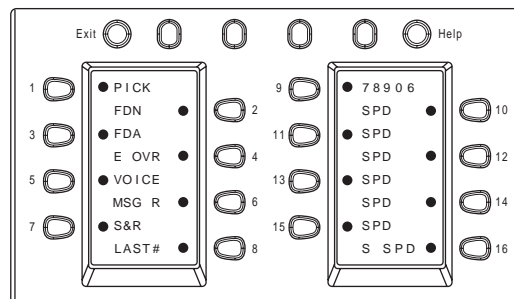

● indicate the icon area. For more detailed description, please refer to the next page.

16 additional programmable keys are provided. They can be programmed as Flexible Line/Programmable feature key by Telephony Server Administrator, similar to existing programmable keys. When Telephony Server Administrator sets “One-Touch Speed Dial key” on the programmable keys, users can assign any numbers (ex. Telephone number, etc.) to the key (up to 8 digits).







\* Maximum 8 characters can be displayed.

\*\* Since Feature Package 20-100 (R18), users can change the name displayed on the LCD. For the LCD indication, refer to **21 16LD Display**. For the operating procedure, refer to **To Register Name On One-Touch Speed Dial key**.

\*\*\* For the assignment of the keys, confirm to the Telephony Server Administrator.



Detailed Descriptions of User's status and Icon:

User' s S tatus	Icon	Flashing P attern
• Idle	No Icon	-
• Call Hold (Individual Hold/Individual Hold on Call Park Group)		Blink <b>Note</b>
• Call Hold (Other Party Hold/Other Party Hold on Call Park Group)		
• Recall (Individual Hold/Exclusive Call Hold/Call Transfer/ Individual Hold on Call Park Group)		Blink <b>Note</b>
• Recall (Other Party Hold/Other Party Hold on Call Park Group) • Incoming Call		
• Exclusive Call Hold		Blink <b>Note</b>
• During Conversation (Individual Use) • Call Transfer • Conference		Steady Lit
• During Conversation (Other Party Use) • Active Feature (Under a setting of feature key like a "Call Forwarding")		

**Note:** *The icon will blink per one second cycle.*

Following picture shows LCD indication of Programmable keys.



OR



Appropriate icons are displayed according to the using feature. These displays cannot be changed by user.

Following pictures shows each LCD indication when One-Touch Speed Dial key is set to Programmable key. Following picture shows the indication of each status.

**When Station line/Trunk line are assigned.**



OR

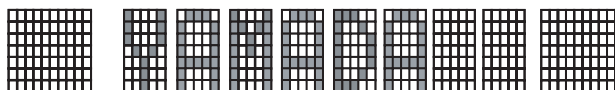

No icons are displayed.

\* Users can register name on each One-Touch Speed Dial key. For the procedures, refer to **To Register Name On One-Touch Speed Dial key. (Note)**

**When any features using feature access code are assigned.**

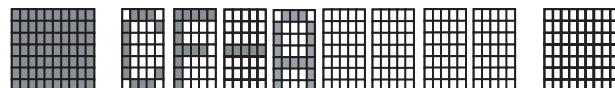

Icons turn black.

\* Users can register name on each One-Touch Speed Dial key. For the procedures, refer to **To Register Name On One-Touch Speed Dial key. (Note)**

**Note)** Available from Feature Package 20-100 (R18) software or later version.

## 16LD ADM

(Available from Feature Package 20-100 R18.)

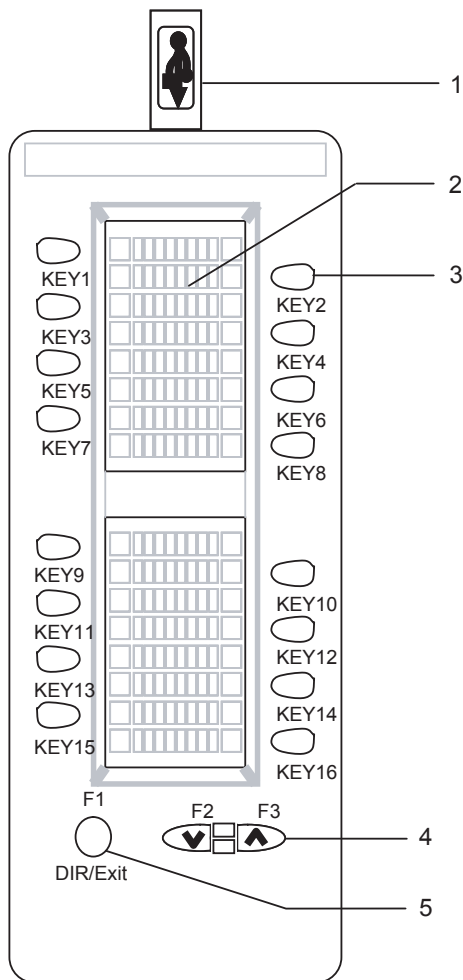

### 1. USB Interface

In Directory mode, users can register telephone data from PC through USB Interface.

(USB Interface: 1.1)

\* For PC Application “ADM Directory” (used to register telephone data), refer to *Manual for PC Application*.

### 2. LCD (Liquid Crystal Display)

LCD provides any name or number registered to each programmable key. Each LCD has 8-character capability.

### 3. Programmable key

These keys can be programmed as Flexible Line key/Programmable Feature Key by Telephony Server Administrator, similar to the programmable key on the telephone itself. These keys are used in both Expansion/Directory mode.

For the details of the modes, refer to the following page.

Note) For the assignment of the keys, confirm to the Telephony Server Administrator.

Note) When two telephone numbers are assigned on A side and B side, user can switch the side by **PAGE** key (Soft key).

Note) LCD indication or more detailed information, refer to **21 16LD Display** in **D<sup>term</sup>16LD** and **D<sup>term</sup>16LDIP**.

#### 4. Scroll key

[Expansion mode]  
Contrast Up/Down

[Directory mode]

Press the key to view the entries.

\* In directory mode, this key scroll one by one when 16 entries are displayed, and when 4 entries are displayed, the key is used to turn the page.

#### 5. DIR/Exit key

Press key to switch Expansion mode to Directory mode.  
Press to cancel the procedure during Directory mode.

### Expansion mode

16 additional programmable keys are provided. They can be used as Flexible Line key/Programmable Feature Key.

When Telephony Server Administrator sets “One-Touch Speed Dial key” on the programmable keys, users can assign any numbers (ex. Telephone number, etc.) to the key (up to 8 digits).

\* For the assignment of the keys, confirm to the Telephony Server Administrator.

\*\* LCD indication or more detailed information, refer to **21 16LD Display in D<sup>term</sup>16LD and D<sup>term</sup>16LDIP.**

### Directory mode

Maximum 100 telephone information can be registered.  
(8 digits for name, 24 digits for telephone number)

- \* Telephone information can be downloaded/uploaded between 16LD ADM and PC through USB interface.
- \*\* For the PC Application “ADM Directory” (used to register telephone data), refer to *Manual for PC Application*.

Maximum 15 Calling History can be stored.

- \* For the detailed information and operating procedures, refer to *Manual for PC Application*.

#### When keys are used in Directory mode.

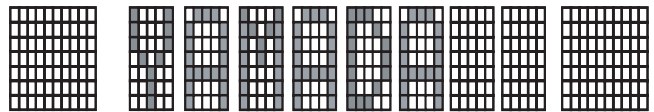

OR

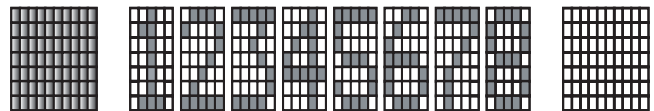

During the call, icons turn black.

\* In Calling History, telephone number is not displayed as it has been called at least once.

## Rear View

D<sup>term</sup>4D IP

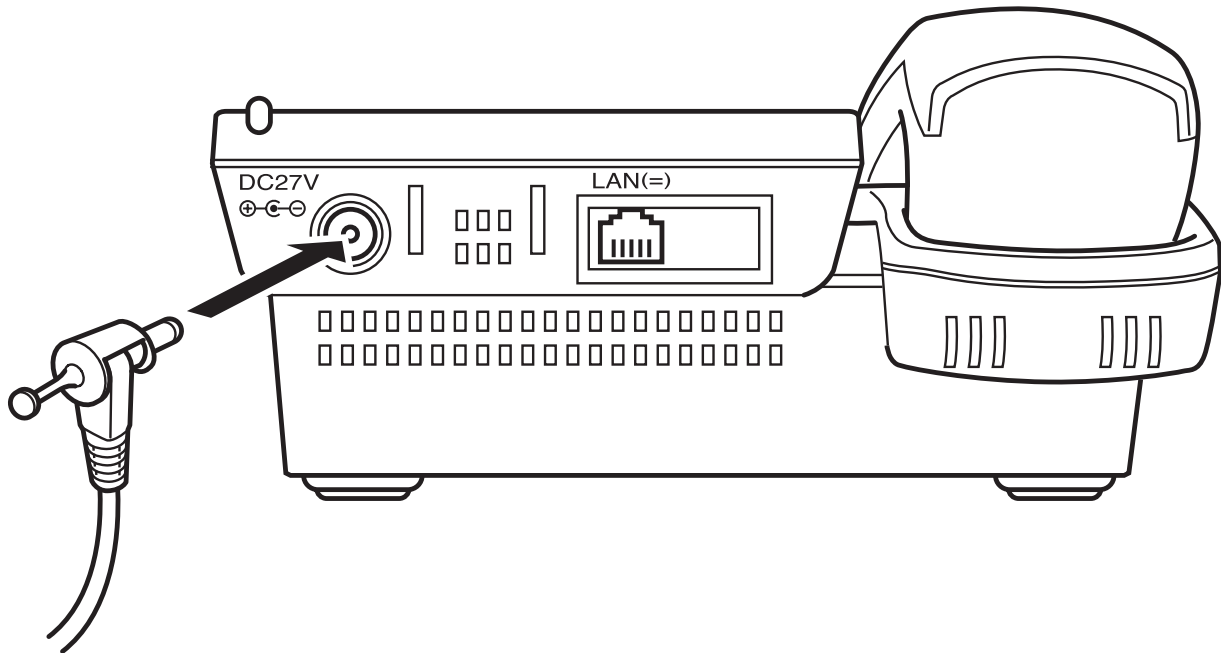

## Network Specification

Interface : Ethernet: 10 Base T/100 Base TX <IEEE 802.3>, RJ45

Internet Layer: IPv4

Protocol : Peer to Peer

Media type : Auto sensing and manual selection supported.

D<sup>term</sup>8D IP, 16D IP, 16LD IP, 32D IP

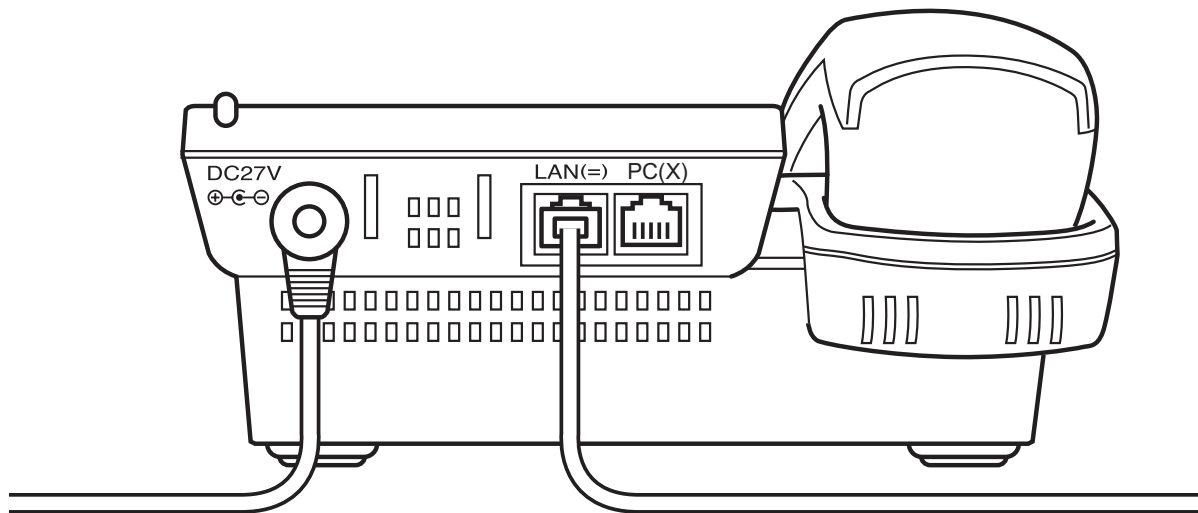

**Note:** *The PC connector on the IP terminal is exclusively for a PC connection, not a second IP terminal.*

## **Network Specification**

Interface : Ethernet 10 Base T/100 Base TX <IEEE 802.3>, RJ45 \* Multiport Switch  
Internet Layer: IPv4  
Protocol : Peer to Peer only  
Media type : Auto sensing and manual selection supported.

D<sup>term</sup>4D IP

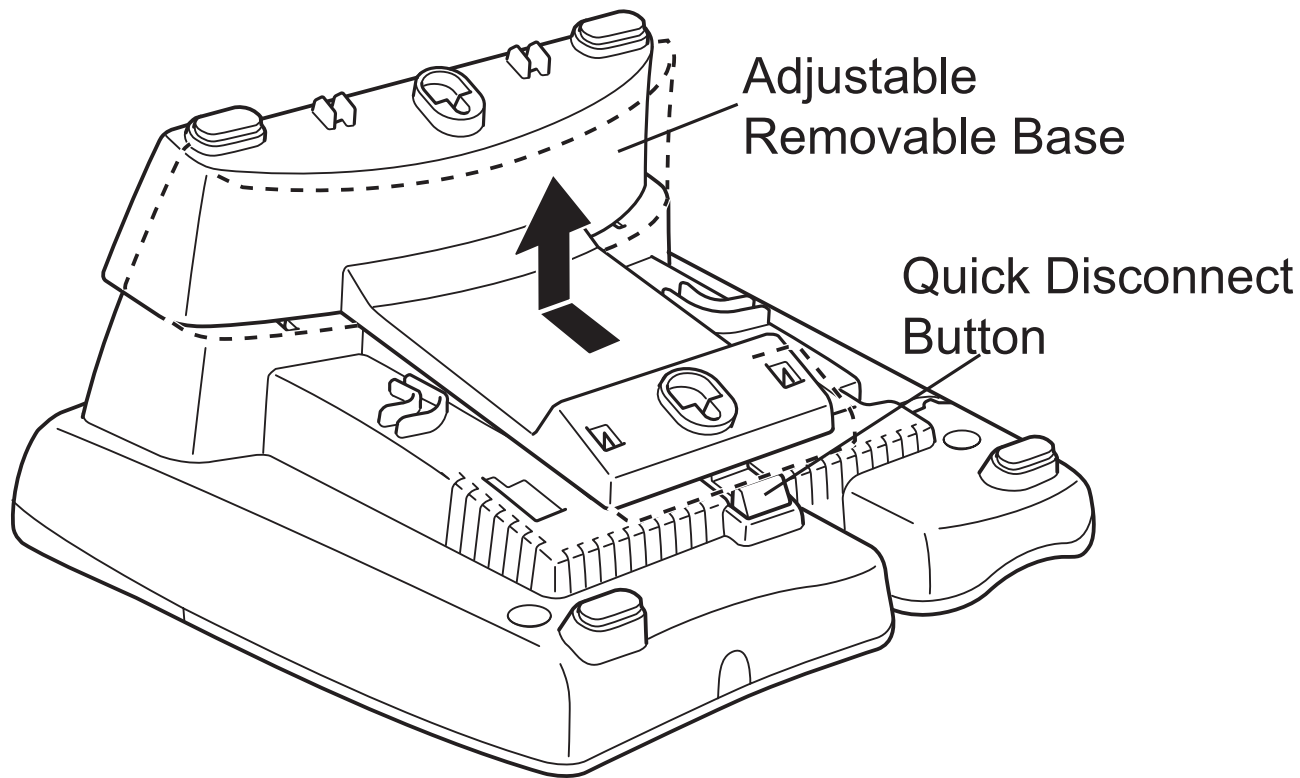

## **Base View**

**D<sup>term</sup>8D IP, 16D IP, 16LD IP, 32D IP**

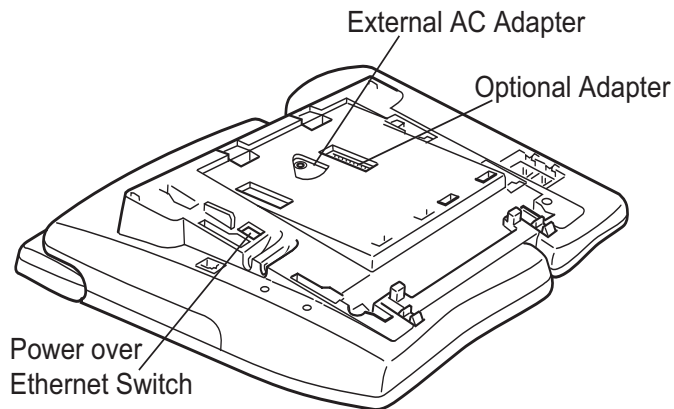

**Note:** *Adjustable/Removable base has been Removed*

<b>Power Method</b>	<b>Equipment to be used</b>	<b>Switch Position</b>
<b>Industry Standard</b>	IEEE 802.3 af Power Switch AC Adapter	1 <Default>
<b>CISCO Discovery Protocol</b>	<ul style="list-style-type: none"><li>• CISCO Catalyst Power Switch</li><li>• CISCO Power Patch Panel</li></ul>	2

## **Optional Adapter supported**

Type	Description
PS(A)-R UNIT	Survivable adapter to provide local Dterm IP survivability.
AD(A)-2R UNIT	Local recording capability.



## **Keys and Lamps**

### **Programmable Keys**

These are examples of D<sup>term</sup>® features available by pressing the programmable keys. Some features using feature access code may be programmed by the user. Others must be programmed by the telephone system administrator.

#### **AICM**

Press key to activate “Automatic Intercom”.

#### **DICM**

Press key to activate “Dial Intercom”.

#### **DND (Do Not Disturb)**

Press key to activate or cancel “Privacy” feature.

#### **FDA**

Press key to activate or cancel “Call Forwarding – All Calls” feature.

#### **FDB**

Press key to activate, verify, or cancel “Call Forwarding – Busy Line” feature.

#### **FDN**

Press key to activate, verify, or cancel “Call Forwarding – Don't Answer” feature.

#### **MICM**

Press key to activate “Manual Intercom”.

#### **MSG (Message)**

Press key to leave message indication at station in no answer or busy condition.

#### **MULTILINE APPEARANCE**

A programmable extra extension key. Press this key to see status of extra extension.

#### **MW-SET**

Press key to leave message waiting indication on boss' station from secretary's station.

#### **MW-OFF**

Press key to cancel message waiting indication on boss' station from secretary's station.

#### **P-RLS**

Press key to release “Privacy” feature.

## **S&R (Save and Repeat)**

Press key to store a number or redial a stored number.

## **SIG**

Press key to cause chime at predetermined station.

## **NAME**

Press key to register name for the key to **One-Touch Speed Calling** key.

*(Available from Feature Package 20-100 R18 software or later version.)*

## **Lamps**

### **Call Indicator Lamp**

Lamp at top of D<sup>term</sup> Display flashes when a call terminates to the terminal.

Lamp lights steadily when a message has been left.

## **LCD**

LCD (Liquid Crystal Display) provides D<sup>term</sup> activity information plus date, time and Soft Key operation.

## **LED**

Some Feature keys have a built-in Light Emitting Diode (LED) that lights or flashes according to the activity of that Feature key.

## **Function Key Activities**

Feature + 0 = Side Tone On/Off. (for handset) **(Note 1)**

Feature + 1 = Turns microphone on or off.

Feature + 2 = Adjusts handset receiver volume

Feature + 3 = Selects ringer tone

Feature + 4 = Adjusts transmission/receiving volume

Feature + 5 = Activates hands-free operation

Feature + 6 = Deactivates hands-free operation

Feature + 7 = Turns call indicator lamp on or off for incoming call notification. (If turned off, this lamp will still light to indicate message waiting.)

Feature + 8 = Turns Dynamic Dial Pad on or off. **(Note 2)**

**Note 1:** *Not available for D<sup>term</sup> IP.*

**Note 2:** *All TDM types support Dynamic Dial Pad. For D<sup>term</sup> IP, Feature Package 8700 (R14) or later version of Firmware is required.*

## Soft Keys

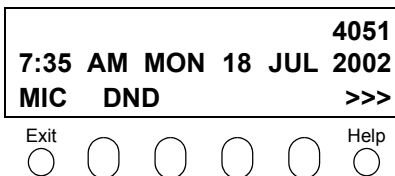

**Note:** *Soft Key function is available for the terminals with LCD.*

The Soft Keys on the D<sup>term</sup> Series i/D<sup>term</sup> IP provide a set of functions on the LCD that adapts to the changing state of the telephone. While default Soft Key settings are provided, desired functions can be assigned to individual stations as required. The Soft Keys, at the bottom of the LCD, can display the names of available functions, names of user-assigned functions and names of functions assigned by a specific Soft Key pattern. The Soft Keys displayed can vary, depending on the state of the phone and/or when the Next/Previous button is pressed.

### **Exit Key**

Press to exit the Help program.

### **Help Key**

Press the Help Key, then press desired Soft Key for helpful information about that key.

### **MIC (Microphone)**

Press the Soft Key below "MIC" to activate or deactivate the Microphone. LED on Mic key will illuminate when Mic is on.

### **DND (Do Not Disturb)**

Press the Soft Key to reject call termination to the preassigned station.

## Default Function Displays for Each Status

Default Soft Key settings are provided corresponding to particular functions. Different Soft Key settings are displayed at the bottom of the LCD depending on the status, as shown below.

Different patterns of Soft Key settings can be registered for individual call states and assigned to individual terminals as required.

IDLE

<b>4:26 PM TUE 13 APR 2004</b>
<b>MIC DND &gt;&gt;&gt;</b>

DIAL TONE/DIALING

(1)

<b>4:26 PM TUE 13 APR 2004</b>
<b>MIC PICK FDA &gt;&gt;&gt;</b>

Push >>>

(2)

<b>4:26 PM TUE 13 APR 2004</b>
<b>FDN FDB &gt;&gt;&gt;</b>

RINGING

<b>4:26 PM TUE 13 APR 2004</b>
<b>MIC VOICE &gt;&gt;&gt;</b>

BUSY

(1)

<b>BUSY</b>	<b>2000</b>
<b>4:26 PM TUE 13 APR 2004</b>	
<b>MIC CB CW &gt;&gt;&gt;</b>	

Push >>>

(2)

<b>BUSY</b>	<b>2000</b>
<b>4:26 PM TUE 13 APR 2004</b>	
<b>S&amp;R &gt;&gt;&gt;</b>	

CONNECTION

	<b>2000</b>
<b>4:26 PM TUE 13 APR 2004</b>	
<b>MIC DND &gt;&gt;&gt;</b>	

CONSULTATION HOLD

<b>TRANSFER</b>	<b>2000</b>
<b>4:26 PM TUE 13 APR 2004</b>	
<b>MIC CONF &gt;&gt;&gt;</b>	

## **Soft Key Features**

When the Soft Key corresponding to a desired function name is operated, the selected function name starts to blink on the LCD. The blinking display of available functions takes precedence over the display of functions specified by the Soft Key pattern. **(Note)**

### **FDB (Call Forwarding – Busy Line)**

Permits a call to a busy station to be immediately forwarded to a predesignated station.

### **FDA (Call Forwarding – All Calls)**

Permits all calls destined for a particular station to be routed to another station regardless of the busy or idle status of the called station.

### **FDL (Logged Out IP Station – Call Destination)**

Enables a system to transfer the call to appropriate station when D<sup>term</sup> whose LOGGED OUT IP STATION – CALL DESTINATION has already been registered is in logout status.

### **E-OVR (Executive Override)**

Enables selected station users, upon encountering a busy condition at an internal station, to bridge into the busy connection.

### **CW (Call Waiting)**

Enables a busy station to receive a second incoming call. A camp-on indication tone is sent to the busy station, and the user can use a switchhook flash to answer the second call.

### **CB (Call Back)**

Provides the ability for a calling station to set a CALL BACK. The calling station will be rung as soon as the busy station becomes available.

### **S&R (Save and Repeat)**

Allows a station to save a specific dialed number and then redial that number later.

### **MWSET (Message Waiting – Set)**

Allows a station to set a Message Waiting indication or lamp.

### **HOLD (Call Hold)**

Permits a station user to hold a call in progress and to return to the previously held call.

### **MWOFF (Message Waiting – Cancel)**

Allows a station to cancel a Message Waiting indication or lamp.

**PICK (Call Pickup – Group)**

Permits a station user to answer any calls directed to other lines in the user's preset Call Pickup Group.

**CONF (Three-way Calling)**

Enables a station user to establish a three-way conference by connecting an additional party to an already existing conversation.

**VOICE (Voice Call)**

Enables the user to make a call to the called party's built-in speaker. If the called party's MIC is on, the called party can converse on hands-free.

**S-SPD (Speed Calling – System)**

Allows a station user to call certain frequently dialed numbers using fewer digits (abbreviated call codes) than would normally be required.

**CAS (CAS-Switch Hook Flash)**

Allows the user to send a switchhook flash while on an outside trunk.

**UCDBO (UCD Busy Out)**

Allows a station user to block UCD calls and to cancel Busy Out.

**FLASH (Flash)**

Provides the station with a switchhook flash.

**FDN (Call Forward – No Answer)**

Permits a call to an unanswered station to be forwarded to a predesignated station if the called station does not answer within a predetermined period of time.

**C-RPT (ISDN Malicious Call Trace)**

Allows the user to initiate a Call Trace on ISDN calls only.

**G-SPD (Speed Calling – Group)**

Allows a station user to share a set of common Speed Calling numbers with other station users in the group.

**P-RLS (Privacy Release)**

Allows another station to depress a busy line button and enter the conversation of a station already engaged in communication.

**DND (Do Not Disturb)**

Allows a station user to deny access to the station line for incoming calls.

**MIC (Microphone On/Off)**

Allows the user to turn the microphone on and off for use with the speakerphone.

**PAGE (Button Page)**

Allows the user to toggle between pages when two numbers are registered on **One-Touch Speed Calling** key.

**HSET (Headset)**

Allows the user to go off- and on-hook when using the headset.

**RLS (Release Key)**

Allows the user to release the current call when using the headset, without waiting for the party to hang up.

**SIG (Manual Signaling)**

Permits station users to send a one-second ring to a predetermined station. If the signaled station is ringing from another call, the manual intercom signal will interrupt that ringing.

**CKEEP (Eight-Party Conference Retrain)**

Allows all outside parties to stay on a conference when all internal parties hang up.

**SCALL (Serial Call)**

Allows the user to set Serial Call for the caller before extending the call, allowing the caller to receive an announcement at the end of the call guiding the caller to dial the next number and subsequent numbers.

**IZP (Internal Zone Paging)**

Allows a user to make a voice call through the speakers of the designated group.

**IDCHG (Call ID Change Display)**

Allows the user to toggle between standard display and an alternate display.

**GPICK (Call Pickup – Group Enhancement)**

Allows the user to answer any ringing station within the user's expanded call pickup group.

**CHCNF (Call Hold – Conference)**

Allows a station user to establish a conference connection by adding a third party, who is held on another line, to the existing two-party connection.



**VISIT (Survivable Remote MGC)**

Allows a station to indicate a status: when a user is in remote office, VISIT will be blinking. After recovering the main office, VISIT will return to light.

**RMUTE (Ringer Mute)**

Allows a station user to mute or recover station ringing.

**>>> (Display Function Next Page)**

Allows the user to scroll to the next display screen.

**<<< (Display Function Previous Page)**

Allows the user to scroll to the previous display screen.

**Note:** *The Soft Keys can be programmed in System Data to blink, remain steady, have no indication, or display a character when either in use or idle.*

## Terminal Setup with the Up/Down Key

**Note:** *Not Displayed for D<sup>term</sup> 65/D<sup>term</sup> Series III and D<sup>term</sup> 75/D<sup>term</sup> Series E mode.*

*D<sup>term</sup> Series III/D<sup>term</sup> Series E : North America*

*D<sup>term</sup> 65/D<sup>term</sup> 75 : Australia, Asia, Latin America, Middle East, Russia*

### **To adjust the handset receiver volume**

Press the Up/Down key in the off-hook status or during the call.

LCD indication for North America, Latin America, Asia, Middle East and Russia.



LCD indication for Australia.



### **To adjust the speaker volume**

Press the Up/Down key during speakerphone operation or engaged in a call.



### **To adjust ringer tone**

Press the Up/Down key during ringing.



### To adjust LCD contrast

Press the Up/Down key in the on-hook status.



**Note:** *When the terminal is connected with 16LD ADM, 16 degrees of LCD contrast are available (8 degrees in terminal side and 2 degrees in ADM itself). (In Expansion mode only, Link motion)*

## Terminal Setup with the Feature Key

### Microphone On/Off

LED on Mic key shows the status of the built-in microphone.

#### To change microphone status

- Press Soft Key associated with the MIC Display or press **Feature** and **1**.

### To adjust initial receiving volume

Handset receiver volume can be changed.

#### To change the handset receiver volume

- Press **Feature** and **2**. The LCD displays the current volume status.
- Press **Feature** and **2** to alternate between Large and Small volume.

<b>RCV VOL.</b>	<b>SMALL</b>
<b>4:26 PM</b>	<b>TUE 13 APR 2004</b>

<b>RCV VOL.</b>	<b>LARGE</b>
<b>4:26 PM</b>	<b>TUE 13 APR 2004</b>

## To select ringer tone

The D<sup>term</sup> Series i/D<sup>term</sup> IP has 10 kinds of ringer tones that you can select.

Press **Feature** and **3**. The LCD displays the selected tone number (n=1 ~ 10).

Tone No.	Frequency (Hz)	Modulation (Hz)
1	520/660	16
2	520/660	8
3	1100/1400	16
4	660/760	16
5	Melody 1	
6	Melody 2	
7	Melody 3	
8	Melody 4	
9	Melody 5	
10	Melody 6	

<b>RINGER TONE</b> n 4:26 PM TUE 13 APR 2004
---

**Note 1:** Tone number 5~10. Available since Feature Package 8600 (R13) and requires the correct version of Firmware.

**Note 2:** Tone number 5, 6, 8~10 (Melody 1, 2, 4~6) will sound continuously.

## To adjust transmission/receiving volume

Handset volume can be changed.

Press **Feature** and **4**. The LCD displays the current volume.

T/R VOL.	SMALL
4:26 PM	TUE 13 APR 2004

Press **Feature** and **4** again to alternate between Small and Large volume.

T/R VOL.	LARGE
4:26 PM	TUE 13 APR 2004

## To activate hands-free

**To set hands-free on:**

Press **Feature** and **5**. The LCD displays:

HANDS FREE	ON
4:26 PM	TUE 13 APR 2004

**To set hands-free off:**

Press **Feature** and **6**. The LCD displays:

HANDS FREE	OFF
4:26 PM	TUE 13 APR 2004

## Call Indicator lamp on/off

The user can choose to turn the call indicator lamp either on or off during ringing.

Press **Feature** and **7**. The LCD displays:

INDICATOR	ON
4:26 PM	TUE 13 APR 2004

INDICATOR	OFF
4:26 PM	TUE 13 APR 2004

**Note:** *The call indicator lamp lights when used as a Message Waiting Lamp, even when it is turned off by the above operation.*

## Dynamic Dial Pad on/off

The user can originate a call at first hand without lifting handset or pressing **Speaker** key.

Press **Feature** and **8**. The LCD displays:

<b>Direct Dial Pad ON</b> <b>4:26 PM TUE 13 APR 2004</b>
---

<b>Direct Dial Pad OFF</b> <b>4:26 PM TUE 13 APR 2004</b>
--

**Note:** *When this feature is ON, the user may initiate a call by immediately dialing the number and the station will go hands-free off-hook automatically. Enabling this feature for a D<sup>term</sup> IP, restricts the terminals ability to enter the D<sup>term</sup> IP User Menu. Please note when the features on the following pages are used in conjunction with Dynamic Dial Pad, that the user does not have to press the Speaker key or lift the handset to receive dial tone.*

## Login/Logout (IP Enabled D<sup>term</sup>/D<sup>term</sup> IP Only)

### To Login

When login mode is activated, following procedure is required.

- Enter login code and press **Set** key.  
(The station number is used as the Login code.)

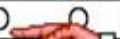
Login :				2000
Passwd :				
Cancel	BK	Set	OK	
<input type="radio"/>	<input type="radio"/>	<input type="radio"/>	<input type="radio"/>	

- Enter the password and press **OK** key.

Login :				2000
Passwd :				*****
Cancel	BK	Set	OK	
<input type="radio"/>	<input type="radio"/>	<input type="radio"/>	<input type="radio"/>	

- If the login code is accepted, display changes to normal idle status.

7:35 AM	MON	18	JUL	2002
MIC	DND			>>>
<input type="radio"/>	<input type="radio"/>	<input type="radio"/>	<input type="radio"/>	



## To Logout

- Press the preassigned logout button on the terminal.

**Note 1:** *This location is an example.*

**Note 2:** *Logout button is assigned by data setting at the PBX.*

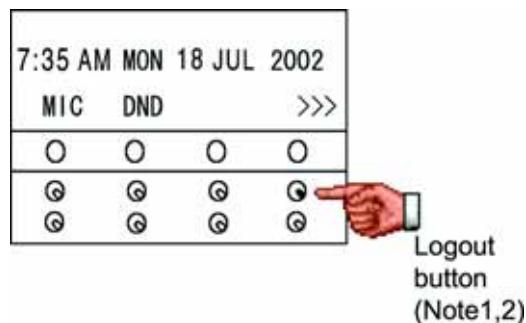

- "LOGOUT?" is displayed on the LCD of the terminal.

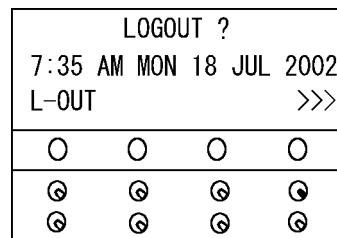

- Press the **logout** button on the terminal again.

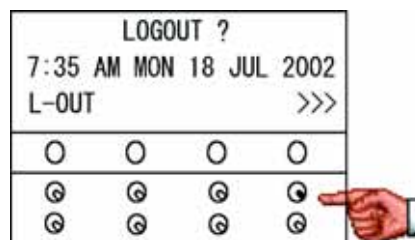

**Note:** *The following pages describe how to use the PBX Features with the D<sup>term</sup> IP. For detailed information pertaining to the D<sup>term</sup> IP only, please refer to feature [I-43] IP Enabled D<sup>term</sup> in the NEAX 2400 IPX Feature Programming Manual.*

## To Originate an Outside Call

- Lift handset or press **Speaker** key, receive dial tone.
  - Dial the Central Office access code (i.e. **9**).
  - Dial desired telephone number.
  - Use handset or MIC to converse.
- Display indicates:

Elapsed time	Trunk type	Trunk number
<b>15:39</b>	<b>DDD</b>	<b>3</b>
<b>4:26 PM</b>	<b>TUE 13 APR 2004</b>	

## To Originate an Internal Call

- Lift handset or press **Speaker** key.
- Receive dial tone.
- Dial desired station number. Display indicates digits dialed.
- Use handset or MIC to converse.

## Multiline Appearance

### **To originate**

- Press the **MULTILINE APPEARANCE** feature key.
- Lift handset or press **Speaker**. Dial the Central Office access code (i.e.9).
- Dial the destination.

### **To answer**

- Press the **MULTILINE APPEARANCE** feature key (ringing and flashing LED alert user to incoming call).
- Lift handset or press **Speaker**.
- Speak with incoming party.

## To Originate a Call Using Speed Calling (One-touch Speed Calling keys)

- Press the desired **One-Touch Speed Calling** key, or press **Speaker** and **One-Touch Speed Calling** key.

### To program

(Available only on D<sup>term</sup> stations with **One-Touch Speed Calling** keys.)

- Press **Feature** button.
- Press desired **One-Touch Speed Calling** key.
- Enter desired telephone number or feature access code on the keypad.  
Display indicates the digits dialed.
- Press **Feature** again to save the number.

<b>SPEED SET</b> 4:26 PM TUE 13 APR 2004
---

### To verify with D<sup>term</sup> 4D/8D/16D/16LD/32D

- Press **Feature** button.
- Press desired **One-Touch Speed Calling** key.
- Display indicates digits programmed.

**Note 1:** *To program a hook switch for transfer or feature activation, press **Recall** key as first digit. (! displays on LCD.)*

**Note 2:** *To program a pause, press the **Recall** key as any digit other than the first digit. (- displays on LCD.)*

**Note 3:** *To program a Voice Call, press **Transfer** key after dialing station number. (V displays on LCD.)*

**Note 4:** ***One-Touch Speed Calling** key for feature access:*

***One-Touch Speed Calling** key may be used as a feature key by storing the NEAX2400 IPX feature access code.*

*The features may be programmed on a system basis by the Telephony Server Admin.*

*Access codes may be stored in conjunction with telephone numbers. For example, one button can be programmed by the user to transfer to a certain extension.*

## LCD Indication of D<sup>term</sup>16LD, D<sup>term</sup>16LDIP and 16LD ADM

(Available from Feature Package 20-100 R18 software or later version.)

Press the desired **One-Touch Speed Calling** key and originate a call.

\* Registered name will be displayed left-justified. For the buttons to which any names are not assigned, the character “SPD” will be displayed.

\*\* Following chart shows the characters that are available for **One-Touch Speed Calling** keys.

Digit Code	Character								
1	1								
2	A	B	C	a	b	c	2		
3	D	E	F	d	e	f	3		
4	G	H	I	g	h	i	4		
5	J	K	L	j	k	l	5		
6	M	N	O	m	n	o	6		
7	P	Q	R	S	p	q	r	s	7
8	T	U	V	t	u	v	8		
9	W	X	Y	Z	w	x	y	z	9
0	0								
*	*	@	.	,	'	:	;	_	/
#	#	&	(	)	[	]	!	?	

\* To enter space, press key or **INS** key.

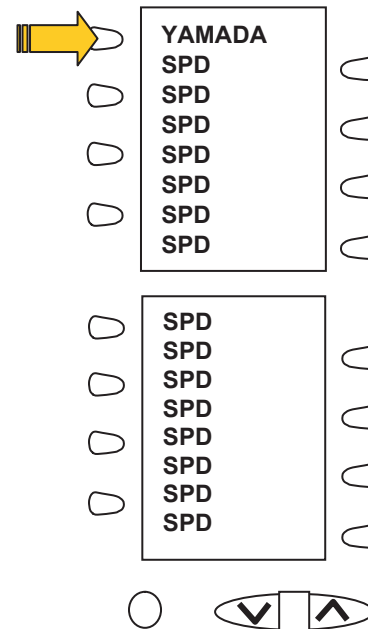

## To Register Name On One-Touch Speed Calling Key

(Available on D<sup>term</sup> stations with **One-Touch Speed Calling** key and 16LD ADM, from Feature Package 20-100 R18 software or later version.)

Press **NAME** button.

```
Push Speed Calling Key
4:26 PM TUE 13 APR 2004
NAME(*) >>>
```

Press desired **One-Touch Speed Calling** key.

Enter desired name on the keypad.  
Display indicates the name entered.

```
NEC BNET
^
SET CANCEL CLEAR >>>
```

Press **SET** to save the name.

```
4:26 PM TUE 13 APR 2004
NAME >>>
```

Note 1) To delete the entry, press **DEL** or **BK** key and delete each one character.

Note 2) To delete the whole setting, press **CLEAR** key and back to idle status.

### To register Speed Calling number on 16LD ADM

Follow the procedure of **To program** in **To Originate a Call Using Speed Calling (One-Touch Speed Calling Keys)**.

## To Originate a Call Using Speed Calling (-Station/Group)

- Press the **Redial** button.
- Press the desired speed calling number.

LNR[*]/SPD[_ _]	-X
	XXXXXX

## To Originate a Call Using Speed Calling – System

### To program Speed Calling – System key (on One-Touch Speed Calling key)

- Press **Feature** key.
- Press desired **One-Touch Speed Calling** key. The LCD displays previously stored digits.
- Dial the “Speed Calling – System” access code and the abbreviated call code.
- Press **Feature** again.

<b>SPEED SET</b>
<b>4:26 PM TUE 13 APR 2004</b>

### To operate from the Speed Calling – System key

- Press the “Speed Calling – System” key.

<b>XXXX</b>
<b>4:26 PM TUE 13 APR 2004</b>

- If the D<sup>term</sup> does not have the “Speed Calling – System” key, dial the “Speed Calling – System” access code, then the abbreviated call code.

### To operate from the Directory key

- Press the Directory key.
- Dial the abbreviated call code (maximum of 4 digits).

<b>XXXX</b>
<b>4:26 PM TUE 13 APR 2004</b>

## To Originate a Call Using Telephone Directory (16LD ADM)

(Available from Feature Package 20-100 R18 software or later version.)

- Press **DIR/Exit** button and enter Directory mode.
- Press initial letter of desired telephone data.

\* For example, "S" in the right figure.

Note) Press **DIR/Exit** button to cancel

Note) When 20 seconds passed without any operation, back to normal status (Expansion mode).

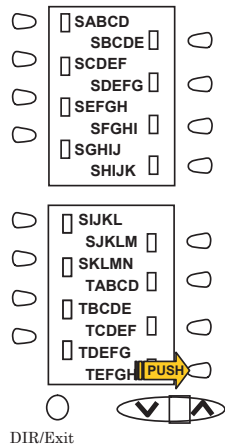

- Telephone data that start with the letter will be displayed by 16 entries. When there are no entries that starts with that letter, entries with next character, will be displayed.

\* For example, "T" in the left figure.

Note) Users can scroll down by one line, with ∨ key.

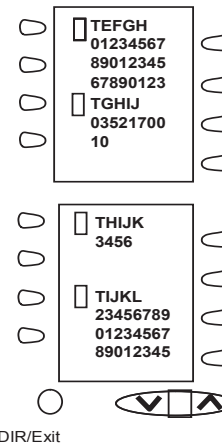
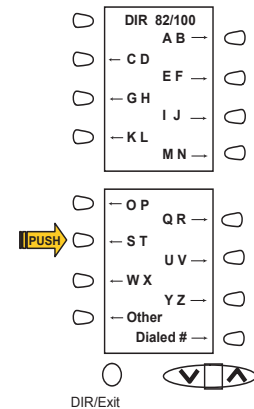

- Press desired button, then detailed information will be displayed by 4 entries.

Note) Users can turn the page with ∨ key.

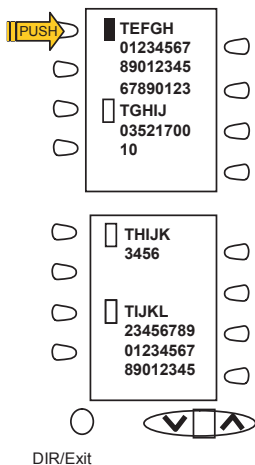

- Registered telephone number will be displayed.
  - Press desired button and originate a call.
- Note) The icon of originating telephone data, will turn black.

- When the call finished, back to normal status (Expansion mode) in 3~5 seconds.

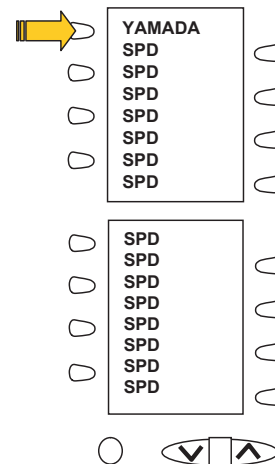

Note 1) When telephone data is not registered to the button, no data will be displayed on LCD. Even pressing the button, the message "Directory entries empty. Please download from PC" will be displayed.

Note 2) To register/delete/modify the telephone data, refer to *Manual for PC Application*.

Space	0	@	P	'	p
!	1	A	Q	a	q
"	2	B	R	b	r
#	3	C	S	c	s
\$	4	D	T	d	t
%	5	E	U	e	u
&	6	F	V	f	v
'	7	G	W	g	w
(	8	H	X	h	x
)	9	I	Y	i	y
*	:	J	Z	j	z
+	;	K	[	k	{
,	<	L		l	
-	=	M	]	m	}
.	>	N	^	n	
/	?	O	_	o	

This chart shows the characters that can be displayed on 16LD ADM.

\* Only half-size alphanumeric characters can be displayed.



## To Originate a Call Using Calling History

(Available from Feature Package 20-100 R18 software or later version.)

Maximum 15 Calling histories can be stored in 16LD ADM.

□ Press <Dialed #> button, then 15 Calling histories that have been originated from 16LD ADM, are displayed.

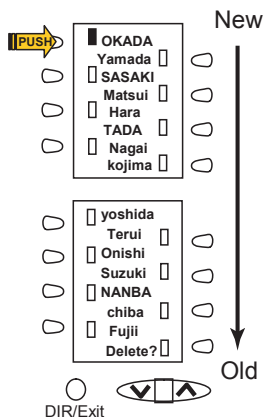

□ Press desired button and originate a call.

Note) Press DIR/Exit button to cancel.

Note) Last 15 Calling histories are displayed from new (at the top) to old.

Note) When originating a call, icon of the selected data will turn black.

Note) As these numbers are already called at least once, only registered name will be displayed. (Telephone number will not be displayed)

□ When the call finished, back to normal status (Expansion mode) in 3~5 seconds.

Note 1) When there are no calling histories, “Dialed # history empty” message will be displayed.

Note 2) To delete calling histories, press “Delete?” during calling histories are displayed, and press desired SPD button.

\* To delete all calling histories, press “ALL?” in this status.

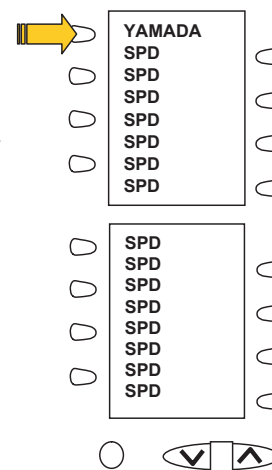
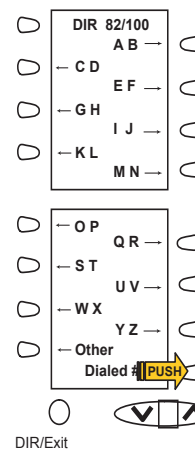

## **Account Code**

### **To enter**

- Lift handset or press **Speaker**, receive dial tone.
- Enter feature access code, receive service set tone.
- Enter “Account Code” (up to 10 digits). **(Note 1)**
- Receive dial tone and dial desired number.

### **To enter account code after authorization code**

- Lift handset or press **Speaker**, receive dial tone.
- Enter feature access code for “Authorization Code”, receive service set tone.
- Enter “Authorization Code”, receive second service set tone.
- Enter “Account Code”, receive dial tone, and dial desired number.

**Note:** *Authorization and Account Codes may be up to 20 digits combined (or 34 digits combined, since Feature Package 8700(R14)).*

## **Forced Account Code**

- Lift handset or press **Speaker**, receive dial tone.
- Enter feature access code, receive service set tone.
- Enter “Forced Account Code” (up to 10 digits), receive dial tone. **(Note 1)**

**Note 1:** *Available for North America since Feature Package 8700 (R14), Account Codes can be up to 24 digits.*

**Note 2:** *Available for North America since Feature Package 8700 (R14), Authorization and Account Codes can be up to 34 digits.*

## Authorization Code

### To enter without account code

- Lift handset or press **Speaker**, receive dial tone.
- Enter feature access code, receive service set tone.
- Enter "Authorization Code" (up to 10 digits).
- Receive dial tone, dial desired number.

### - Or -

- Lift handset, receive dial tone.
- Dial desired number.
- If an "Authorization Code" is required, caller hears special dial tone.
- Enter "Authorization Code", or call will be denied.

**Note:** *This option is available only if system is programmed with Least Cost Routing.*

### To enter with account code (see above)

Service set tone is optional depending upon system programming.

**Note:** *If a 4-, 8- 16- or 32-button display terminal is used, the display indicates all of the digits dialed.*

## Voice Call

- Lift handset
- Dial desired station number.
- Press **Voice**.

- Speak to called party.

<b>VOICE</b>	<b>2000</b>
<b>4:26 PM</b>	<b>TUE 13 APR 2004</b>

## Using the Soft key

- Lift handset
- Dial desired station number; **VOICE** Soft Key appears while station is ringing.
  
- Press **VOICE** Soft Key. Speak to called party.

**Note 1:** *A Voice Call may be programmed on a **One-Touch Speed Calling** key by pressing **One-Touch Speed Calling** key, dialing the extension, and pressing the **Transfer** key. (V displays if programming on an  $D^{term}$  with Display. Save by pressing **One-Touch Speed Calling** key again.)*

**Note 2:** *If called party is on their line when a Voice Call is attempted, calling station's display indicates:*

				2000
4:26 PM	TUE 13	APR 2004		
MIC	VOICE			>>>

**Note 3:** *A voice call is restricted if called party's station is not a  $D^{term}$ . Display indicates:*

<b>VOICE BUSY</b>				
4:26 PM	TUE 13	APR 2004		

<b>VOICE REST</b>				
4:26 PM	TUE 13	APR 2004		

## To Answer a Voice Call Hands Free

- Receive incoming Voice Call.
- Press the **MIC** Soft Key or **Mic**. LED lights.
- Respond hands-free.

**Note:** *If privacy is required, lift handset.*

				Calling station
<b>VOICE</b>				2001
4:26 PM	TUE 13	APR 2004		

## Automatic Intercom

### To initiate

- Lift handset or press **Speaker** key.
- Press the **AICM** key.
- Hear ringback tone.

Called party

<b>ICM</b>	<b>2</b>
<b>4:26 PM TUE 13 APR 2004</b>	

### To answer

- AICM** key flashes red indicating an incoming intercom call.

Calling party

<b>ICM</b>	<b>1</b>
<b>4:26 PM TUE 13 APR 2004</b>	

- Press **AICM**, lift handset or press **Speaker**. LED lights solid green.
- If called station is engaged in a non-intercom call, the station may press **AICM** after placing original caller on hold (with **HOLD** key).

### To bridge into an automatic intercom call

**Note:** *Bridging is an optional feature.*

- Press the **AICM** key, lift handset or press **Speaker**.

Overriding party

<b>OVERRIDE</b>	<b>1</b>
<b>4:26 PM TUE 13 APR 2004</b>	

- A three-party conference is established.

<b>CONF</b>	
<b>4:26 PM TUE 13 APR 2004</b>	

## Manual Intercom

### To initiate

- Press **MICM**, lift handset or press **Speaker**, ringback tone is heard.
- Press the **SIG** key if it is desired for the called station to hear ringing.

Called party

<b>ICM</b>	<b>2</b>
<b>4:26 PM</b>	<b>TUE 13 APR 2004</b>

### To answer

- MICM** key flashes, indicating an incoming call. Ring tone may also be heard.
- Press **MICM**.
- Lift handset or press **Speaker**, LED lights solid green.
- If called station is engaged in a non-intercom call, the station may press **MICM** after placing original caller on hold (with **Hold** key).

Calling party

<b>ICM</b>	<b>1</b>
<b>4:26 PM</b>	<b>TUE 13 APR 2004</b>

### To bridge into a manual intercom call

**Note:** *Bridging is an optional feature.*

- Press **MICM**, lift handset or press **Speaker**.
  
- A three-party conference is established.

Overriding party

<b>OVERRIDE</b>	<b>1</b>
<b>4:26 PM</b>	<b>TUE 13 APR 2004</b>

<b>CONF</b>	
<b>4:26 PM</b>	<b>TUE 13 APR 2004</b>

**Note 1:** *The **SIG** key signals the corresponding station when speaking over the intercom path is unnecessary.*

**Note 2:** *Two-button Manual Intercom provides one button for signalling and one for talking. A separate signalling button can be used in many ways for the secretary to alert a boss, or vice versa.*

## Dial Intercom

### To initiate

- Lift handset or press the **Speaker** key.
- Press **DICM** key.
- Dial desired intercom station number. Receive ringback tone.

Called party

<b>ICM</b>	<b>2</b>
<b>4:26 PM TUE 13 APR 2004</b>	

### To answer

- DICM** LED flashes, indicating an incoming intercom call.
- Press **DICM**.
- Lift handset or press **Speaker**. LCD shows solid green.
- If called station is engaged in a non-intercom call, the station may press **DICM** after placing the original call on hold (with the **Hold** key.)

Calling party

<b>ICM</b>	<b>2</b>
<b>4:26 PM TUE 13 APR 2004</b>	

### To bridge into a dial intercom call

**Note:** *Bridging is an optional feature.*

- Press the **DICM** key, lift handset or press **Speaker**.

Overriding party

<b>OVERRIDE</b>	<b>3</b>
<b>4:26 PM TUE 13 APR 2004</b>	

- A three-party conference is established.

<b>CONF</b>	
<b>4:26 PM TUE 13 APR 2004</b>	

**Note:** *Dial intercom provides a Dial Intercom group where each member of the group may be called by a 1- or 2-digit number without using their prime lines.*

## To Place a Call on Hold

- Press **Hold**. Held line flashes.

**Note:** *If held line appears on other D<sup>term</sup> stations, the associated LED flashes red slowly.*

### To retrieve

- Lift handset or press **Speaker**.
- Press held line. Use handset to converse.

**Note:** *Any station with this line appearance can retrieve the call.*

### If unanswered

- After preprogrammed time, Automatic Recall is initiated.
- Visual and audible signal (rapid flash and ring burst) is sent to station that placed call on hold.

**Note 1:** *A transfer or conference call may be placed on hold depending on software level of the NEAX2400 IPX.*

**Note 2:** *Hold shows as a flashing green LED on your phone. The same line on other phones shows as a flashing red LED.*

**Recall** shows as a flashing green LED on your phone and flashing red LED on other phones with the same line.

## To Place a Call on Exclusive Hold

- Press **Hold** twice. Line appearance indicates interrupted wink.

**Note:** *If held line appears on other D<sup>term</sup> stations, LED remains steadily lit red.*

### To retrieve

- Lift handset or press **Speaker**.
- Press held line. Use handset to converse.

**Note:** *Only the D<sup>term</sup> that set Exclusive Hold option can retrieve the call.*

Held station  
number

<b>HOLD</b>	<b>2001</b>
<b>4:26 PM</b>	<b>TUE 13 APR 2004</b>

Held station  
number

<b>E_HOLD</b>	<b>2001</b>
<b>4:26 PM</b>	<b>TUE 13 APR 2004</b>



## If unanswered

- After preprogrammed time, Automatic Recall is initiated.
- Visual and audible signal (rapid flash and ring burst) is sent to station which placed call on Exclusive Hold. **Recall** shows as a flashing green LED on your phone, and solid red on other phones with same line.

**Note:** *Exclusive Hold excludes any other phone from picking up your held call. Exclusive Hold shows as a flashing green LED on your phone. The same line on other phones appears as a solid red LED.*

## To Transfer a Call

- After conversing, ask party to hold.
- Press **Transfer**. Receive interrupted dial tone.

<b>TRANSFER</b> <b>4:26 PM TUE 13 APR 2004</b>
---

Transferred station  
or trunk number

- Dial destination station's extension, hang up or wait for answer.

<b>TRANSFER</b> <b>2001</b> <b>4:26 PM TUE 13 APR 2004</b>
---

Transferring station

- If transferring party hangs up, that station's number appears in the center of recipient's display.

<b>TRANSFER 2000</b> <b>DDD 3</b> <b>4:26 PM TUE 13 APR 2004</b>
---

## Conference

- With call in progress, ask party to hold.
- Press **Transfer**, receive interrupted dial tone.
- Dial desired number.
- After call is answered, press **Conf**. **Conf** LED lights.
- Three-way conference is established.

<b>CONF</b> <b>4:26 PM TUE 13 APR 2004</b>
---

## Using the Soft Key

- With a call in progress, press **Transfer** and dial desired number.
- After call is answered, press **CONF** Soft Key.  
Three-way conference is established.
- If one party hang up, other two remain connected.  
**Conf** LED goes out.

<b>CONF</b> <b>4:26 PM TUE 13 APR 2004</b> <b>MIC &gt;&gt;&gt;</b>
--

## To Establish a Broker Call

- While engaged in a call and wishing to consult a third party, press **Transfer**. Caller is automatically placed on hold.
- Dial desired party to consult.
- Press **Transfer** to return to original caller. Third party is automatically placed on hold.
- By repeating these steps, it is possible to alternate between calls.

**Note:** *The display indicates connected station or trunk at any given time.*

## To Answer a Camped-on Call

- While engaged in a call, receive the camp-on indication (one short tone burst). **Answer** LED flashes.
- Press **Answer**. Call in progress is placed on hold.
- Connection to camped-on call is established.
- Press **Answer** to return to original call.  
Camped-on call is placed on hold.
- By repeating these steps, it is possible to alternate between calls.  
Display indicates connected station or trunk at any given time.

	Trunk type	Trunk number
<b>CAMP ON</b>	<b>DDD</b>	<b>3</b>
<b>4:26 PM</b>	<b>TUE 13</b>	<b>APR 2004</b>

## Call Waiting – Originating

### To program call waiting key (on One-Touch Speed Calling key)

- Press **Feature**.
- Press desired **One-Touch Speed Calling** key.
- Press **Recall**. ! appears on LCD. (See **Note**.)
- Dial “Call Waiting” feature access code.
- Press **Feature**.

**Note:** *To program a hook switch for transfer or feature activation, press **Recall** as first digit. ! displays on LCD.*

### To activate call waiting – originating

- Dial desired station number, receive busy tone.
- Press **CALL WAITING**.
- Receive special ringback tone.
- Call waiting tone is sent to busy station.

	Called station number
<b>C WAIT</b>	<b>2000</b>
<b>4:26 PM</b>	<b>TUE 13</b>
	<b>APR 2004</b>

– Or –

- Lift handset or press **Speaker**.
- Dial “Call Waiting” access code, receive dial tone.

- Dial busy station.

### Using the Soft Key

- Dial desired station and receive busy tone.
- Press **CW** Soft Key receive call waiting ringback tone.

### To answer a waiting call

- Call Waiting Tone is heard.
- Press **Answer**.
- Waiting call is automatically connected. Original party is placed on hold.
- By repeatedly pressing **Answer**, it is possible to alternate between calls.  
Display indicates connected station or trunk at any given time.

### Using the Soft Key

- Hear burst of tone Display indicates “**C WAIT**” and **Answer** button flashes.
- Press **Answer** receive call waiting tone.

### To disconnect

- Press **Recall**. Station user is automatically connected to original party.

<b>C WAIT</b> <b>4:26 PM TUE 13 APR 2004</b>
---

<b>C WAIT SET</b> <b>2000</b> <b>4:26 PM TUE 13 APR 2004</b>
---

Called station  
number

<b>C WAIT SET</b> <b>2000</b> <b>4:26 PM TUE 13 APR 2004</b> <b>MIC</b> <b>&gt;&gt;&gt;</b>
---

Calling station  
number

<b>C WAIT</b> <b>2001</b> <b>4:26 PM TUE 13 APR 2004</b>
---

Calling station  
number

<b>C WAIT</b> <b>2001</b> <b>4:26 PM TUE 13 APR 2004</b> <b>MIC</b> <b>&gt;&gt;&gt;</b>
---

## Call Park

### To program call park key (on One-Touch Speed Calling key)

- Press **Feature**.
- Press **One-Touch Speed Calling** key.
- Press **Recall**. ! displays on LCD.
- Dial "Call Park" access code.
- Press **Feature** again.

### To park a call

- While connected to a station or trunk, press **CALL PARK**.

Parked station  
or trunk

<b>CALLPARK SET</b>	<b>DDD 3</b>
<b>4:26 PM</b>	<b>TUE 13 APR 2004</b>

### To retrieve a parked call from originating station

- Dial "Call Park" local retrieval code.
- Station user is connected to parked call.

Elapsed time

<b>10:01</b>	<b>DDD 2</b>
<b>4:26 PM</b>	<b>TUE 13 APR 2004</b>

### To retrieve a parked call from a remote station

- Dial "Call Park" remote retrieval code and the station number from which the call was parked.
- Station user is connected to remotely parked call.

Station that  
parked the call

<b>2000</b>	<b>DDD 2</b>
<b>4:26 PM</b>	<b>TUE 13 APR 2004</b>

## Call Pick-up (Group)

### When station within pick-up group rings

- Lift handset.
- Press **CALL PICK-UP** or dial “Call Pick-up” access code (may be stored on **One-Touch Speed Calling** key).
- Connection to calling party is established.
- If currently on a call, press **Transfer** and dial “Call Pick-up” access code.  
The original party is placed on hold.

	Called station	Calling party
<b>PICK UP</b>	<b>2000 DDD</b>	<b>3</b>
<b>4:26 PM</b>	<b>TUE 13 APR 2004</b>	

### Using the Soft Key

- Lift handset and press **PICK** Soft Key.
- Connection to calling party is established.

	Called station	Calling party
<b>PICK UP</b>	<b>2000</b>	<b>2001</b>
<b>4:26 PM</b>	<b>TUE 13 APR 2004</b>	
<b>MIC</b>		<b>&gt;&gt;&gt;</b>

## Call Pick-up (Direct)

### To program pick-up direct key (One-Touch Speed Calling key)

- Press **Feature**.
- Press **One-Touch Speed Calling** key.
- Dial “Direct Call Pick-up” access code.
- Press **Feature** again.

### When a station within the system rings

- Lift handset, receive dial tone.
- Press **PICK-DIRECT** and dial the station number to be picked up.

– Or –

- Dial “Direct Call Pick-up” access code and the station number to be picked up.
- Connection to calling party is established.
- If busy, original call must be placed on hold before new call can be picked up.

	Called station	Calling party
<b>PICK UP</b>	<b>2000 DDD</b>	<b>3</b>
<b>4:26 PM</b>	<b>TUE 13 APR 2004</b>	

## Outgoing Trunk Queuing

### If trunk busy

- Receive Trunk Busy indication. Press **CALL BACK**. Call is placed in queue for next available trunk.
- When trunk is available, setting station is alerted by ringing and flashing red LED.
- Press **Speaker** or lift handset. Dial tone is heard or number is automatically dialed if Least Cost Routing is provided.

<b>OG-Q SET</b>
<b>4:26 PM TUE 13 APR 2004</b>

## Off-hook Trunk Queuing

- Press **Speaker**, receive dial tone.
- Dial desired telephone number. Encounter a trunk busy condition.
- Station user receives service set tone and leaves speaker on.
- The desired number is automatically dialed when a trunk becomes available.

## Executive Override

### If called station is busy

- Press **VERRIDE**.
- Interrupted parties receive warning tone.

- Three-way conference is initiated.
- Conf** LED lights.

### Using the Soft Key

- Press **E-OVR** Soft Key.
- Interrupted parties receive warning tone and three-way conference is initiated.

Overridden station

<b>VERRIDE</b>	<b>2001</b>
<b>4:26 PM</b>	<b>TUE 13 APR 2004</b>

<b>CONF</b>	
<b>4:26 PM</b>	<b>TUE 13 APR 2004</b>

<b>VERRIDE</b>	<b>2001</b>
<b>4:26 PM</b>	<b>TUE 13 APR 2004</b>
<b>MIC</b>	<b>&gt;&gt;&gt;</b>

**Note:** *Override may be programmed by the Telephony Server Admin. for one of the Programmable Feature keys, or may be programmed by the user on an **One-touch Speed Calling** key by storing the Recall and Override access code.*

## Last Number Redial

### To Recall the Last Number Dialed

- Press **Redial**. Last number dialed is displayed.
- Press **Redial** key until desired number is displayed. Up to 5 previously dialed numbers.
- Press **#** or **\* (Note)**. The number on the display is automatically redialed.
- When party has answered, lift handset or speak handsfree.

<b>LNR[# or *]/SPD[ _ ]</b>	<b>-X</b>
	<b>XXXXXX</b>

**Note:** *A-law Countries [Australia, Russia, Latin America, UK, Middle near East, other Asian nations]: #*  
*μ-law Countries [North America, Japan, Hong Kong, Taiwan]: \**



## Call Forwarding – All Calls

### To set

- Press **Speaker**. Receive dial tone.
- If setting for another station, press **MULTILINE APPEARANCE**.
- Press **FWD** or dial “Call Forwarding – All Calls” access code. Receive special dial tone.
- Dial destination station or external telephone number. Receive service set tone.
- FWD** LED lights (at your station or at the D<sup>term</sup> of the multiline station you are setting).
- Press **Speaker**. Call Forwarding – All Calls is set.

Forwarding  
station

<b>FORWARD SET</b>	<b>2000</b>
<b>4:26 PM</b>	<b>TUE 13 APR 2004</b>

### Using the Soft Key

- Press **FDA** Soft Key. Receive special tone.
- Dial destination; wait for service set tone.
- “**FORWARD SET**” is displayed, call forwarding for all calls is set.

<b>FORWARD SET</b>
<b>4:26 PM TUE 13 APR 2004</b>
<b>MIC &gt;&gt;&gt;</b>

### To verify (with D<sup>term</sup> 4D/8D/16D/16LD/32D)

- Press **FWD**.
- Display indicates the station number calls are forwarded to.

Forwarding  
station

**Note 1:** *If recipient station is a D<sup>term</sup> 4D/8D/16D/16LD/32D, LCD displays:*

**Note 2:** *With Soft Key operation, FDB flashes on the display.*

<b>FORWARD</b>	<b>2000</b>
<b>4:26 PM</b>	<b>TUE 13 APR 2004</b>

## To cancel

- Press **Speaker**. Receive dial tone. If cancelling for another station, press **MULTILINE APPEARANCE**.
- Press **FWD** or dial “Call Forwarding – All Calls” cancel code. Receive service set tone. LED goes out at your station (or the D<sup>term</sup> of the multiline station).
- Press **Speaker**. Call Forwarding – All Calls is cancelled.

<b>FORWARD CANCEL</b> 4:26 PM TUE 13 APR 2004
--

## Using the Soft Key

- Press **FDA** Soft Key.
- Receive service set tone and “**FORWARD CANCEL**” is displayed.

<b>FORWARD CANCEL</b> 4:26 PM TUE 13 APR 2004 MIC >>>
---

## Call Forwarding – Busy Line

### To set

- Press **Speaker**. Receive dial tone.
- If setting for another station, press **MULTILINE APPEARANCE**.
- Press **FWD-BY** or dial “Call Forwarding – Busy Line” access code. Receive special dial tone.
- Dial destination station or external telephone number. Receive service set tone.
- FWD-BY** LED lights (at your station or at the D<sup>term</sup> of the multiline station you are setting).
- Press **Speaker**. Call Forwarding – Busy Line is set.

<b>FORWARD SET</b> 4:26 PM TUE 13 APR 2004
---

## Using the Soft Key

- Press **FDB** Soft Key. Receive special dial tone.
- Dial destination; wait for service set tone.
- “**FORWARD SET**” is displayed; Call Forwarding – Busy Line is set.

<b>FORWARD SET</b> 4:26 PM TUE 13 APR 2004 MIC >>>
--

## To verify (with D<sup>term</sup> 4D/8D/16D/16LD/32D)

- Press **FWD-BY**.
- Display indicates the station number calls are forwarded to.  
**Note 1:** *If recipient station is a D<sup>term</sup> 4D/8D/16D/16LD/32D, LCD displays:*  
**Note 2:** *With Soft Key operation, FDB flashes on the display.*

Forwarding station

<b>FORWARD</b> 2000 4:26 PM TUE 13 APR 2004
--

## To cancel

- Press **Speaker**. Receive dial tone. If cancelling for another station, press **MULTILINE APPEARANCE**.
- Press **FWD-BY** or dial “Call Forwarding – Busy Line” cancel code. Receive service set tone. LED goes out at your station (or the D<sup>term</sup> of the multiline station).
- Press **Speaker**. Call Forwarding – Busy Line is cancelled.

<b>FORWARD CANCEL</b> 4:26 PM TUE 13 APR 2004
--

## Using the Soft Key

- Press **FDB** Soft Key.
- Receive service set tone and “**FORWARD CANCEL**” is displayed.

<b>FORWARD CANCEL</b> 4:26 PM TUE 13 APR 2004 MIC >>>
---

## Call Forwarding – Don't Answer

### To set

- Press **Speaker**. Receive dial tone.
- If setting for another station, press **MULTILINE APPEARANCE**.
- Press **FWD-NA** or dial “Call Forwarding – Don't Answer” access code. Receive special dial tone.
- Dial destination station or external telephone number. Receive service set tone.
- FWD-NA** LED lights (at your station or at the D<sup>term</sup> of the multiline station you are setting).
- Press **Speaker**. Call Forwarding – Don't Answer is set.

Forwarding  
station

<b>FORWARD SET</b>	<b>2000</b>
<b>4:26 PM</b>	<b>TUE 13 APR 2004</b>

### Using the Soft Key

- Press **FDN** Soft Key. Receive special dial tone.
- Dial destination; wait for service set tone.
- “**FORWARD SET**” is displayed; Call Forwarding – Don't Answer is set.

<b>FORWARD SET</b>
<b>4:26 PM TUE 13 APR 2004</b>
<b>MIC &gt;&gt;&gt;</b>

### To verify (with D<sup>term</sup> 4D/8D/16D/16LD/32D)

- If verifying for another station, press **MULTILINE APPEARANCE** while idle.
- Press **FWD-NA**.
- Display indicates the station number calls are forwarded to.

Forwarding  
station

**Note 1:** *If recipient station is a D<sup>term</sup> 4D/8D/16D/16LD/32D, LCD displays:*

<b>FORWARD</b>	<b>2000</b>
<b>4:26 PM</b>	<b>TUE 13 APR 2004</b>

**Note 2:** *Call Forwarding for Busy Line and Don't Answer may be combined depending upon system programming.*

**Note 3:** *With Soft Key operation, **FDB** flashes on the display.*

## To cancel

- Press **Speaker**. Receive dial tone. If cancelling for another station, press **MULTILINE APPEARANCE**.
- Press **FWD-NA** or dial “Call Forwarding – Don’t Answer” cancel code. Receive service set tone. LED goes out at your station (or the D<sup>term</sup> of the multiline station).
- Press **Speaker**. Call Forwarding – Don’t Answer is cancelled.

<b>FORWARD CANCEL</b> 4:26 PM TUE 13 APR 2004
--

## Logged Out IP Station – Call Destination

### To set

- Lift handset or press **Speaker** key.
- Press the FDL Key or dial “Logged Out IP Station – Call Destination” access code.
- Dial destination station number; receive service set tone.
- Replace handset or press **Speaker** key.  
Logged Out IP Station – Call Destination is set.

<b>FORWARD SET</b> XXXX 4:26 PM TUE 13 APR 2004
--

### Using the Soft Key

- Press **FDL** Soft Key; receive special Dial Tone.
- Dial destination station number.
- Receive service set tone; “**FORWARD SET**” is displayed.

<b>FORWARD SET</b> XXXX 4:26 PM TUE 13 APR 2004 MIC >>>
---

### To verify (with D<sup>term</sup> 4D/8D/16D/16LD/32D)

- Press “Logged Out IP Station – Call Destination” feature key lit red or press **FDL**.
- Display indicates the station number calls are forwarded.

<b>FORWARD</b> XXXX 4:26 PM TUE 13 APR 2004
--

**Note:** *With Soft Key Operation, FDL flashes on the display.*

## To cancel

- Lift handset or press **Speaker** key; receive Dial Tone.
- Press the FDL Key or dial “Logged Out IP Station – Call Destination” cancel code; receive service set tone.
- Replace handset or press **Speaker** key. Logged Out IP Station – Call Destination is canceled.

**FORWARD CANCEL**  
**4:26 PM TUE 13 APR 2004**

## Using the Soft Key

- Lift handset or press **Speaker** key; receive Dial Tone.
- Press **FDL** Soft Key; receive service set tone.
- Dial destination station number; receive service set tone.
- “Logged Out IP Station – Call Destination” lamp goes off and FDL indication disappears on the LCD.

**FORWARD CANCEL**  
**4:26 PM TUE 13 APR 2004**  
**MIC >>>**

## Call Back

### If called station is busy

- Press **CALL BACK**. Receive service set tone.

Called party

<b>CALLBACK SET</b>	<b>2000</b>
<b>4:26 PM</b>	<b>TUE 13 APR 2004</b>

### – Or –

- Press the **FLASH** key and enter “Call Back” access code.
- When both parties become idle, calling party’s phone rings. Calling party would go off hook and hear ring back tone.  
The called station would then be ringing.
- Connection is established when the called party answers.

Called party

<b>CALLBACK</b>	<b>2000</b>
<b>4:26 PM</b>	<b>TUE 13 APR 2004</b>

Called party

<b>CALLBACK</b>	<b>2001</b>
<b>4:26 PM</b>	<b>TUE 13 APR 2004</b>

**Note:** *Call Back may be programmed by the Telephony server admin. on a Programmable feature key or by the user on an **One-Touch Speed Calling** key.*

### Using the Soft Key

- Press **CB** Soft Key and receive service set tone.
- “**CALLBACK SET**” is displayed and the **CB** Soft Key flashes on the display.

<b>CALLBACK SET</b>	
<b>4:26 PM</b>	<b>TUE 13 APR 2004</b>
<b>MIC</b>	<b>&gt;&gt;&gt;</b>

## To Save and Repeat a Number

### To save

- Press **Speaker**.
- Dial desired telephone number.
- Press **S&R**. Dialed number is now stored. **S&R** LED lights.

### – Or –

- Receive internal call.
- Press **S&R**. Number is stored in memory.
- S&R** LED lights.

### Using the Soft Key

- Press **S&R**. Number is stored in memory.
- S&R** LED lights.

### To verify (with D<sup>term</sup> 4D/8D/16D/16LD/32D)

- While idle, press **S&R**.
- Display indicates digits sorted.

### To repeat

- Press **Speaker**.
- Press **S&R**. D<sup>term</sup> automatically redials the programmed number.
- S&R** automatically cancelled. LED goes out.

**Note:** *If saved number is busy or no answer is received, to save it again, press **S&R** again before hanging up.*

### Using the Soft Key

- Press flashing **S&R** Soft Key. Stored number is automatically redialed. “**S&R**” disappears from display.



## To Leave a Message

- Press **Speaker**. Receive dial tone.
- Dial desired station number. Encounter no answer or busy condition.
- Press **MSG**. Message is sent to called D<sup>term</sup>.
- Called station **MSG** LED lights.

**Note 1:** *Up to four messages can be stored in D<sup>term</sup> memory.*

**Note 2:** *If a fifth message is attempted, reorder tone is heard and display indicates:*

**Note 3:** *If station is not equipped to receive messages, reorder tone is heard and display indicates:*

Called station

<b>MESSAGE SET</b> <b>2001</b>
<b>4:26 PM TUE 13 APR 2004</b>

<b>MESSAGE BUSY</b>
<b>4:26 PM TUE 13 APR 2004</b>

<b>MESSAGE REST</b>
<b>4:26 PM TUE 13 APR 2004</b>

## To Answer a Message

### To display

- MSG** LED is lit. Station is idle.
- Press **MSG**.
- Re-press **MSG** to display additional messages in order received.

Calling  
station

<b>MSG 2001</b> <b>12:28PM</b>
<b>4:26 PM TUE 13 APR 2004</b>

### To respond

- While displaying desired message, press **Speaker**.
- Press **MSG**. Station which left message is automatically redialed.
- Message is erased.

## To erase

- To erase a message without returning the call, press **MSG** to display desired message.
- Dial # or ✕ while message displays. Message is erased.

**Note:** *If station that left message is busy, callback or **MSG** may be set. If station that left message does not answer, **MSG** may be set, notifying originating party that a message return was attempted.*

<b>MESSAGE CANCEL</b> <b>4:26 PM TUE 13 APR 2004</b>
---

## Voice Mail System

### To set

- Press **Feature** key.
- Press **Message** key.
- Dial desired "Voice Mail System" access code.
- Press **Feature** again.

<b>SPEED SET</b> <b>4:26 PM TUE 13 APR 2004</b>
--

### To originate

- Press **Message** key.
- Hear ringback tone.

## Meet-me Paging

Example: Station A can page Station B. When Station B dials answer code, they are connected.

### To page (station A)

- Dial "Paging" access code, receive continuous ringback for one second.
- Page station B.
- Remain off hook or hang up.

Trunk number

<b>PAGING</b>	<b>3</b>
<b>4:26 PM TUE 13 APR 2004</b>	

### To answer (station B)

#### If station A remains off hook

- Station B dials "Paging" answer code, and they are immediately connected.

<b>PAGING</b>	<b>3</b>
<b>4:26 PM TUE 13 APR 2004</b>	

#### If station A hung up

- Station B dial "Paging" answer code, and Station A D<sup>term</sup> rings.
- When station A goes off-hook, they are connected.

**Note:** *Paging function can not be supported with IP enabled D<sup>term</sup> and D<sup>term</sup> IP.*

## Paging Transfer

Example: Station A receives an important call for Station B who is not at a desk. Station A can page Station B. When Station B dials the Paging answer code, Station A can announce the call and transfer it to Station B.

Calling trunk  
number

<b>TRANSFER</b>	<b>DDD 3</b>
<b>4:26 PM</b>	<b>TUE 13 APR 2004</b>

### Station A paging

- Ask calling party to hold.
- Press **Transfer**. Receive interrupted dial tone.
- Dial "Paging" access code. Receive continuous ringback for one second.
- Page Station B.
- Remain off-hook or hang up.

### To answer (Station B)

#### If Station A remained off hook

- Station B dials "Paging" answer code, and is connected with Station A. Station A announces call.

Stations A and B each display  
the other's number

<b>TRANSFER</b>	<b>XXXX</b>
<b>4:26 PM</b>	<b>TUE 13 APR 2004</b>

- Station A hangs up. Station B and the calling party are connected.

	<b>DDD 3</b>
<b>4:26 PM</b>	<b>TUE 13 APR 2004</b>

#### If Station A hung up

- Station B dials "Paging" answer code. Station A D<sup>term</sup> rings.

Stations A and B each display  
the other's number, flashing

<b>TRANSFER</b>	<b>DDD 3</b>
<b>4:26 PM</b>	<b>TUE 13 APR 2004</b>

- Station A picks up and announces call.
- Station A hangs up. Station B and the calling party are connected.

Calling trunk number

	<b>DDD 3</b>
<b>4:26 PM</b>	<b>TUE 13 APR 2004</b>

**– Or –**

(Dependent on System Programming)

- Station B dials “Paging” answer code, and is immediately connected to the calling party.

<b>PAGING</b>	<b>DDD 3</b>
<b>4:26 PM</b>	<b>TUE 13 APR 2004</b>

## **Boss/Secretary Transfer**

### **Secretary**

- Lift handset, press boss’ ringing line. Ask calling party to hold.
- Press boss’ line again. “Voice Call” is automatically established.
- Announce the call to the boss.

Calling party

	<b>DDD 3</b>
<b>4:26 PM</b>	<b>TUE 13 APR 2004</b>

Boss and secretary station each display the other’s number

<b>ICM</b>	<b>XXXX</b>
<b>4:26 PM</b>	<b>TUE 13 APR 2004</b>

### **If boss accepts call**

- Secretary replaces handset.
- Boss lifts handset, presses flashing line.

### **If boss refuses call**

- Secretary presses boss’ line to return to calling party.

## Boss/Secretary – MW Lamp Control

### To set MW at boss' station

#### With caller on the line

- Lift handset or press **Speaker**.
- Press boss' ringing line. Ask calling party to hold.
- Press the **MW-SET** line/feature key.  
No service set tone is heard.

Boss sees **MW** on display and can call secretary to receive message.

<b>MW SET</b> <b>4:26 PM TUE 13 APR 2004</b>
---

#### Without caller on the line

- After taking message, press **Recall** and receive dial tone.
- Press the **MW-SET** line/feature key. Receive service set tone.

<b>MW SET</b> <b>4:26 PM TUE 13 APR 2004</b>
---

**Note:** *The secretary can hang up after taking a message, and set a message lamp at any time by going off-hook on the boss' multiline and pressing the **MW-SET** key.*

### To cancel at boss' station

#### Without caller on the line

- Lift handset or press **Speaker**. Receive dial tone.
- Press Boss' line appearance.
- Press **MW-CANCEL** line/feature key. Receive service set tone.

<b>MW</b> <b>4:26 PM TUE 13 APR 2004</b>	<b>CANCEL</b>
---	---------------

#### With caller on line

- While engaged in conversation on boss' multiline, press **MW-CANCEL** key.  
No service set tone is heard.

<b>MW</b> <b>4:26 PM TUE 13 APR 2004</b>	<b>CANCEL</b>
---	---------------

## Boss/Secretary Override

Example: Station 2000 is boss, Station 2001 is secretary.  
Boss is connected to Trunk A.  
Incoming call on Trunk B connects to secretary, but is intended for boss.

### To program boss/secretary override key

- Press **Feature**.
- Press a **One-Touch Speed Calling** key.
- Dial "Boss/Secretary Override" access code.
- Press **Recall**. – displays on LCD.
- Dial boss' station number.
- Press **Feature** again.

### Secretary

- Lift handset to answer Trunk B, ask caller to hold.
- Press **CALL HOLD** feature key or **Transfer** and dial call hold access code.  
Receive dial tone.
- Press **BOSS/SEC OVERRIDE**.  
Receive ringback tone.

Boss' station  
number

<b>C WAIT</b>	<b>2000</b>
<b>4:26 PM</b>	<b>TUE 13 APR 2004</b>

### Boss

- Hear 3 bursts of tone. LCD display indicates:

Secretary's station  
number

<b>C WAIT</b>	<b>2001</b>
<b>4:26 PM</b>	<b>TUE 13 APR 2004</b>

### Option 1

- Boss presses **Answer** and converses with secretary. Trunk A is placed on hold.
- Secretary hangs up. Boss is connected to Trunk B.
- Boss can alternate between the two parties by pressing **Answer**.

### Option 2

- Boss presses **Answer** and converses with secretary. Trunk A is placed on hold.
- Boss presses station 2001 key and converses with Trunk B. Boss presses **Answer** to reconnect to Trunk A.
- Secretary hears reorder tone, hangs up.
- Boss can alternate between the two parties by pressing **Answer**.

### Option 3

- If boss does not respond to 3 bursts of tone, secretary presses **Recall**.
- Secretary is connected to Trunk B.

### Option 4

- Boss presses **Answer** and converses with Secretary. Trunk A is placed on hold.
- Boss denies call, presses **Transfer** to return to Trunk A.
- Secretary is returned to Trunk B.

**Note:** *If boss has 4/8/16/16LD/32 button display terminal, display always indicates the connected station or trunk at any given time.*

## Do Not Disturb

### While idle (on hook)

- Press **DND**. LED lights.

**Note:** *With Soft Key operation, “DND” flashes when set.*

<b>DND SET</b> <b>4:26 PM TUE 13 APR 2004</b>
--

### To cancel

- Press **DND**. LED goes out.

<b>DND CANCEL</b> <b>4:26 PM TUE 13 APR 2004</b>
---

### Using the Soft Key

- Press flashing **DND** Soft Key.

**Note:** *DND must be programmed by the Telephony Server Admin. on a Programmable Feature key.*

<b>DND CANCEL</b> <b>4:26 PM TUE 13 APR 2004</b> <b>MIC DND &gt;&gt;&gt;</b>
--



## **Call Redirect**

Example: D<sup>term</sup> Station A views on the D<sup>term</sup> display the Station Number or Caller ID of an Incoming Call and immediately redirects the call by pressing a Function Key. The destination of the Call Redirect will be the Call Forwarding-Don't Answer Destination or the Recall Destination if the call is transferred without Call Forwarding-Don't Answer being set at the station.

**Note:** *This feature is available in North America only.*

### **Call Redirects to the Call Forward-Don't Answer Destination:**

- Station A sets Call Forward-Don't Answer to Station B.
- Station C dials Station A, it rings and displays Station C's number on the display.
- Station A presses the Call Redirect Key.
- REDIRECT is displayed on the LCD, and the call immediately forwards to Station B.

### **Using the Soft Key**

- Station A sets Call Forward-Don't Answer to Station B.
- Station C dials Station A, it rings and displays Station C's number on the display.
- Station A presses the REDIR Soft Key.
- REDIRECT is displayed on the LCD, and the call immediately forwards to Station B.

**- Or -**

### **Call Redirects to the Recall Destination when call is transferred without Call Forwarding-Don't Answer being set.**

- Station B calls Station C.
- Station C answers the call and transfers it to Station A and then releases the call.
- Station A rings.
- Station A presses the Call Redirect Key.
- REDIRECTING is displayed on Station A and the call immediately recalls to Station C.

## Using the Soft Key

- Station B calls Station C.
- Station C answers the call and transfers it to Station A and then releases the call.
- Station A rings.
- Station A presses the REDIR Soft Key.
- REDIRECTING is displayed on Station A and the call immediately recalls to Station C.

## Privacy

### While off-hook

- Press **DND**. LED lights.
- Privacy feature prevents interruptions for the duration of the call.

**PRIVACY SET**  
4:26 PM TUE 13 APR 2004

### Using the Soft Key

- Press flashing **DND** Soft Key. "DND" flashes when set.
- Privacy feature prevents interruptions for the duration of the call.

**PRIVACY SET**  
4:26 PM TUE 13 APR 2004  
MIC >>>

### To cancel

- Press **DND**. LED goes out.

**PRIVACY CANCEL**  
4:26 PM TUE 13 APR 2004

### – Or –

- Replace handset. Privacy feature is automatically cancelled.

**Note:** **DND** *must be programmed by the Telephony Server Admin. on a Programmable feature key.*

### Using the Soft Key

- Press flashing **DND** Soft Key.

**PRIVACY CANCEL**  
4:26 PM TUE 13 APR 2004  
MIC DND >>>

## Privacy Release

Example: D<sup>term</sup> Station B is engaged in a conversation, and allows D<sup>term</sup> Station A to enter the call in progress.

- Station A lifts handset or presses **Speaker**.  
Station A presses the line appearance of Station B.  
Warning tone is sent to the interrupted parties (optional).  
A three-way conference is established.

<b>CONF</b> <b>4:26 PM TUE 13 APR 2004</b>
---

**Note:** *Station A may also be a single-line station as long as it appears on the Station B D<sup>term</sup>.*

**– Or –**

Example: D<sup>term</sup> Station A requests entrance into Station B's call in progress.

- Station A lifts handset or presses **Speaker**.
- Station A presses the line appearance of Station B.
  
- Station B LCD indicates:
- Station B may allow Station A to enter the conversation by pressing **P-RLS**.
- Warning tone is sent to the interrupted parties (optional).
  
- A three-way conference is established.

<b>WAIT P-RLS?</b> <b>4:26 PM TUE 13 APR 2004</b>
--

<b>P-RLS?</b> <b>4:26 PM TUE 13 APR 2004</b>
---

<b>CONF</b> <b>4:26 PM TUE 13 APR 2004</b>
---

**Note 1:** *Station A can be a single-line station if it appears on the Station B D<sup>term</sup>.*

**Note 2:** *Up to six parties can break into a two-party conversation (additional device required).*

## LCD Indication

**15:39            DDD            X**

Time elapsed, trunk type and number for outside call  
Time elapsed for parked call

**XXX            DDD            X**

Parked call retrieved from a remote station, showing  
the number of the station that parked the call

### **C**

**CALLBACK                            XXXX**

Call Back is activated, showing called or calling number

**CALLBACK SET                        XXXX**

Call Back set for busy called station

**CALLPARK SET                        X**

Incoming call is parked

**CAMP ON            DDD            X**

Camped on call placed on hold

### **CONF**

Three-party conference established  
Conference for Executive Override  
Conference for Privacy Release

**C WAIT                                XXXX or**

**C WAIT SET                            XXXX**

Call Waiting tone sent to or received at busy station  
show in called or calling number  
Call received on boss' station from secretary's station

### **D**

**DND SET/CANCEL**

Do Not Disturb set or cancelled

**Direct Dial Pad ON/OFF**

Dynamic Dial Pad status

### **E**

**E-HOLD                                XXXX**

Station placed on Exclusive Hold

### **F**

**FORWARD                                XXXX**

Station displays forwarding destination  
Call Forwarding – All Calls  
Call Forwarding – Busy Line  
Call Forwarding – Don't Answer  
Logged Out IP Station – Call Destination

**FORWARD SET/CANCEL**

Call Forwarding set or cancelled  
Call Forwarding – All Calls  
Call Forwarding – Busy Line  
Call Forwarding – Don't Answer  
Logged Out IP Station – Call Destination

### **H**

**HANDS FREE                            ON/OFF**

Hands free status

## LCD Indication (continued)

**HOLD**                                      **XXXX**

Station placed on hold

### **I**

**ICM**                                      **X**

Intercom call with called or calling party number

Automatic Intercom

Manual Intercom

Dial Intercom

Boss Secretary Transfer

**INDICATOR O/OFF**

Indicator Lamp status

### **L**

**LNR[\*]/SPD[ ]-n**

Prompt for last number called or

Speed Calling number

Stack Dial

**Login**

The IP Enabled D<sup>term</sup> becomes operational when the user enters "Login Code" and "Password".

**Logout**

Press preassigned Logout button to logout.

### **M**

**MSG XXXX HH:MMPM**

Message waiting (calling station and time of message)

**MESSAGE BUSY**

Called station message memory Busy – cannot store addition messages

**MESSAGE CANCEL**

Message erased

**MESSAGE REST**

Called Station message receipt restricted – not equipped to receive messages

**MESSAGE SET**                                      **XXXX**

Message indication left and busy called station

**MW SET/CANCEL**

Message Waiting set or cancelled on boss' station from secretary's station

### **O**

**OG-Q SET**

Outgoing Trunk Queue – call placed in queue for next available outgoing trunk

## LCD Indication (continued)

**OVERRIDE**                           **X**  
Overriding intercom call through bridging  
Automatic Intercom  
Dial Intercom  
Manual Intercom

**OVERRIDE**                           **XXXX**  
Executive Override

### **P**

**PICK UP**                               **XXXX**   **X**  
Call Pickup of station within group showing called and  
calling stations

**PAGING**                           **X** or  
**PAGING**       **DDD**           **X**  
Ready to page station, page waiting or page call con-  
nection

**P-RLS SET**  
Privacy Release set

**P-RLS ?**  
Prompt requesting privacy release for incoming call

**PRIVACY SET/CANCEL**  
Privacy set or cancelled

### **R**

**RCV VOL. SMALL/LARGE**  
Receiver Volume status

**RINGER TONE**                   **X**  
Ready for Ringer tone selection

### **S**

**SPEED SET**  
Speed Calling number saved in memory

### **T**

**TRANSFER**  
Ready to transfer a call

**TRANSFER**                           **XXXX**  
Transferred station or trunk number  
Page Call Transfer

**TRANSFER**   **XXXX**           **X**  
Transferring station number

**TRANSFER**                           **3**  
Transferring page call to another station

**T/R VOL. SMALL/LARGE**  
Transmission Receiving Volume status

### **V**

**VOICE**                               **XXXX**  
Voice Call showing called or calling station number

**VOICE BUSY/REST**  
Voice Call station called is busy or restricted

## **W**

### **WAIT P-RLS?**

Prompt when requesting privacy release at another station



## Index